



VIVAX
METROTECH

vLoc3-9800 User Handbook **(English Edition)**

Version 1.1

P/N: 4.04.000107



Table of Content

- 1. General Safety & Care Information 1
 - 1.1 Who Can Use This Equipment 1
 - 1.2 Work-site Safety 1
 - 1.3 Equipment Safety 1
 - 1.4 Batteries and Environmental Safety 1
 - 1.4.1 Alkaline Batteries 1
 - 1.4.2 Nickel-Metal Hydride Batteries (rechargeable)..... 1
 - 1.4.3 Lithium-ion Batteries (rechargeable) 2
 - 1.4.4 Lithium-metal Batteries (non-rechargeable) 2
 - 1.4.5 General Rules regarding Disposal of Batteries 2
 - 1.4.6 Transportation of Lithium-ion and Lithium-metal Batteries 2
 - 1.5 Care of Equipment..... 2
 - 1.6 Care when Interpreting the Information provided by the Locator 3
 - 1.7 American & Canadian Safety Notices 3
- 2. Service & Support..... 4
 - 2.1 Serial Number and Software Revision Number 4
 - 2.2 Distributors and Service Centers Closest to You: 5
- 3. vLoc3-9800 Receiver..... 6
 - 3.1 vLoc3-9800 Receiver Overview..... 6
 - 3.2 Charging the Receiver Batteries..... 7
 - 3.3 vLoc3-9800 Receiver Keypad..... 8
 - 3.4 Setup Menu 10
 - 3.4.1 About 10
 - 3.4.2 Speaker Volume 10
 - 3.4.3 Backlight..... 10
 - 3.4.4 Frequency..... 10
 - 3.4.5 Language..... 11
 - 3.4.6 Imp/Metric..... 11
 - 3.4.7 Continuous Info 11
 - 3.4.8 Auto Power Off 11
 - 3.4.9 Warnings 11
 - 3.4.10 Bluetooth Pairing (optional feature)..... 11
 - 3.4.11 Satellite Info 11
 - 3.4.12 Transmitter Control..... 11
 - 3.5 Self-Test..... 11
 - 3.6 Warnings..... 12
 - 3.6.1 Signal Overload 12
 - 3.6.2 Shallow Cable..... 12
 - 3.6.3 Swing Alert..... 12
 - 3.6.4 Overhead Cable 12
 - 3.7 Locating Mode 13



3.7.1	Auto Left/Right Mode (Active modes only i.e. not available in Power or Radio modes)	13
3.7.2	Manual Left/Right Mode (Active modes only i.e. not available in Power or Radio modes)	14
3.7.3	Manual Peak Display Mode	14
3.8	Information Pushbutton - Depth & Current	15
3.9	Passive and Active Location	16
3.9.1	Passive Locating	16
3.9.2	Active Locating	17
3.10	Applying the Transmitter's Signal	17
3.10.1	Direct Connection	17
3.10.2	Clamp	18
3.10.3	Induction	18
3.10.4	Searching an Area	19
3.10.5	Tracing a Buried Line	19
3.10.6	Pinpointing & Confirming the Buried Line	20
3.10.7	Measuring Depth and Current	20
3.10.8	Distorted Fields	21
3.10.9	Locating Non-metallic Pipes or Ducts	21
4.	Data Logging	24
4.1	Bluetooth	25
4.1.1	Fitting the Bluetooth Module	25
4.2	Pairing with external GPS/Dataloggers	26
4.3	Transferring Data from the Locator to a Computer	26
4.3.1	MyLocator3	27
4.3.2	MyLocator3's Basic Operation	27
4.3.2.1	Updates Page	27
4.3.2.2	Application Update	28
4.3.2.3	Locator Firmware update	28
4.3.3	Toolbar	29
4.3.4	Data Logging	30
4.3.5	Splash Screen	30
4.3.6	Frequencies Page	31
4.3.7	Menu Settings	32
4.3.8	Advanced Features	33
4.3.8.1	Supervisor Lockouts	33
5.	Loc3-10Tx Transmitter	34
5.1	Loc3-10Tx Transmitter Overview	34
5.1.1	Display	34
5.1.2	Pushbutton	35
5.1.3	Information Pushbutton	35
5.1.4	Connections Block	35
5.2	Transmitter Battery	36
5.2.1	Removing the Battery Tray	36
5.2.2	Replacing the Alkaline Battery	36
5.2.3	Rechargeable Batteries	37

5.2.4	Re-fitting the Battery Tray.....	37
5.2.5	Rechargeable Battery Pack Charging and Disposal	37
5.3	Transmitting Modes	38
5.3.1	Induction Mode.....	38
5.3.2	Direct Connection Mode.....	38
5.3.3	Clamp Mode	39
5.4	Frequencies	39
5.4.1	Frequencies and Power Output.....	39
5.4.2	Most Used Frequencies Feature	40
5.4.3	Multi-frequency Mode for Direct Connection	42
5.5	Remote the Operation of transmitter	43
6.	Loc3-5Tx Transmitter.....	47
6.1	Loc3-5Tx Transmitter Overview.....	47
6.1.1	Display.....	47
6.1.2	Pushbuttons.....	48
6.1.3	Information Pushbutton	48
6.2	Transmitter Battery	48
6.2.1	Removing the Battery Tray.....	49
6.2.2	Replacing the Alkaline Battery.....	49
6.2.3	Rechargeable Batteries.....	49
6.2.4	Re-fitting the Battery Tray.....	49
6.2.5	Rechargeable Battery Pack Charging and Disposal	50
6.3	Transmitting Modes	50
6.3.1	Induction Mode.....	50
6.3.2	Direct Connection Mode.....	51
6.3.3	Clamp Mode	51
6.4	Frequencies	52
6.4.1	Frequencies and Power Output.....	52
6.4.2	Most Used Frequencies (Frequency Selection) Feature	53
6.4.3	Multi Frequency Mode for Direct Connection	54
6.5	Transmitter Battery	56
6.5.1	Replacing Alkaline Batteries	56
6.5.2	Rechargeable Batteries.....	56
6.5.3	Battery Charging and Disposal.....	56
7.	Using the vLoc3-9800.....	57
7.1	Using the Accessories	57
7.1.1	Using the LPC Separation Filter	57
7.1.2	Using the Analogue A-frame Fault Finding Accessory.....	57
7.1.3	Using the vLoc3 Remote Antenna.....	61
8.	Accessories & Options.....	64
8.1	A-frame	64
8.2	Remote Antenna	64
8.3	Loc3-10Tx Vehicle Power Lead.....	64
8.4	Loc3-10Tx Outdoor Power Supply.....	64

8.5	LPC Separation Filter	64
8.6	Receiver Vehicle Charging Lead	65
8.7	Sondes.....	65
8.8	Clamps.....	65
8.9	Clamp Extension Rod.....	65
8.10	Ground Extension Spool.....	66
8.11	Banana Plug Adapter	66
8.12	Loc3-5Tx and Loc3-10Tx Charger/PS	66
8.13	Loc3-5Tx and Loc3-10Tx Rechargeable Battery Tray	66
8.14	vLoc3-MLA.....	66
9.	Glossary	67



1. General Safety & Care Information

1.1 Who Can Use This Equipment

- This equipment must only be used by people suitably trained in the use of pipe and cable locators.

1.2 Work-site Safety

- Use your company's, or other applicable safety code and rules when using this equipment.
- Unless having the required authorization, license and appropriate training – **do not** make connections to any pipe, cable or conductor.
- The equipment should not come in contact with corrosive or hazardous chemicals, gases, or dust.
- **Do not** directly connect this equipment to cables or pipes that have a potential difference to ground of greater than 25V AC.

1.3 Equipment Safety

- **Do not** open the housings of either the transmitter or receiver.
- Place the ground stake firmly in the ground before connecting the cable from the transmitter.
- **Do not** hold any uninsulated portion of the connection leads & clips when the transmitter is switched on.

1.4 Batteries and Environmental Safety

Vivax-Metrotech products use four types of batteries:

- Alkaline batteries
- Nickel metal hydride batteries – rechargeable
- Lithium-ion batteries – rechargeable
- Lithium-metal batteries – small non-rechargeable button cells for “clock” applications

1.4.1 Alkaline Batteries

- When replacing the alkaline batteries – use only the size and type specified – **do not** mix battery types (rechargeable and alkaline).
- **Do not** mix partially discharged and fully charged cells in the same battery pack – **do not** mix old with new.
- Never attempt to charge alkaline batteries.

1.4.2 Nickel-Metal Hydride Batteries (rechargeable)

- When using rechargeable batteries, **use only the correct charging device** supplied or specified by the manufacturer. The battery pack or the battery charger will contain circuitry to manage the charging process – other chargers, even if they have the same connector, polarity, voltage & current rating, will not have the same control circuitry and can cause damage to the product, overheating, and in extreme cases fire or harm to the individual.
- **Do not** assume that if the plug fits it is the correct charger – a charger with the correct part number **must** be used – just because it is a Vivax-Metrotech charger, and the plug fits **does not** mean it is the correct charger.
- Before using for the first time, charge rechargeable batteries for six hours. If at any time the rechargeable batteries **do not** last as long as anticipated – discharge fully and then charge for six hours.
- Care should be taken when charging batteries – **never** repeatedly recharge batteries, or turn power off & on, without using the instrument. If used with an inverter in a vehicle – charge the product then unplug the charger and **do not** charge again until the rechargeable batteries have been used for at least ten minutes. Failure to do this could result in the overcharging of the battery which will shorten the life of the battery and could in some circumstances cause overheating or fire.
- If ever the product becomes hot during the charging process **immediately** unplug the charger and use the rechargeable batteries for at least ten minutes before recharging. If this reoccurs the next time the unit is charged – return **immediately** to Vivax-Metrotech for repair.

1 General Safety & Care Information

- **Do not** charge batteries for prolonged periods of time without using the locator for at least ten minutes. Charging for prolonged period of time could overcharge the battery, reduce the battery life and in extreme circumstances can cause damage to the locator and fire.

1.4.3 Lithium-ion Batteries (rechargeable)

- Lithium-ion batteries – some products use Lithium-ion batteries – the requirements for marking and transportation are still developing. Please contact Vivax-Metrotech before shipping products containing Lithium-ion batteries or Lithium-ion battery packs on their own for any “special instructions”.

1.4.4 Lithium-metal Batteries (non-rechargeable)

- Commonly known as “button cells”, these are small non-rechargeable batteries used to power internal “clocks” within some units, similar to computers. Generally, they have a life of three to five years.
- Under no circumstances should any attempt be made to charge these batteries.
- Dispose of in accordance with your company’s work practice/environmental standards, the prevailing laws, or recognized best practice. Always dispose batteries responsibly.

1.4.5 General Rules regarding Disposal of Batteries

- **Never** disassemble a battery, or battery pack.
- **Never** dispose in a fire or water.
- Dispose batteries in accordance with your company’s work practice/environmental standards, the prevailing laws, or recognized best practice. Always dispose batteries responsibly.

1.4.6 Transportation of Lithium-ion and Lithium-metal Batteries

- The Lithium-ion and Lithium-metal batteries used in Vivax-Metrotech products meet the required safety standards and include the designated protection circuitry.
- Recent regulation changes require when Lithium-ion and Lithium-metal batteries are transported; the packaging **must** include specified warning labels.
- **Please contact Vivax-Metrotech Customer Service (USA 1-800-446-3392, International +1-408-734-1400 USA Pacific Time Zone) for more details.**
- Regulations have also changed regarding the shipping of spare battery packs (battery packs that are not inside a product). There are limitations on the weight of the package, and the packaging must be marked with the appropriate warning labels.
- **Please contact Vivax-Metrotech Customer Service (USA 1-800-446-3392, International +1-408-734-1400 USA Pacific Time Zone) for more details.**
- Vivax-Metrotech vLoc Series 3 products using Lithium-ion battery are classified as “not restricted” and can be shipped normally by road/rail/sea & air, passenger & freight aircraft without restrictions.



IMPORTANT

Remember – batteries contain dangerous chemicals – they can be affected by many things such as water ingress or heat. In some circumstances they can explode. They also can cause electric shocks!

1.5 Care of Equipment

- Use equipment only as directed in this user handbook.
- **Do not** immerse any part of this equipment in water.
- Store in a dry place.
- Keep equipment in the case provided when not in use.
- If left for prolonged period of time – remove alkaline batteries.
- Keep unit clean and free of dust and dirt.
- Protect against excessive heat.

1.6 Care when Interpreting the Information provided by the Locator

- Like all locators – this instrument is locating and providing depth and current readings based on electromagnetic signals that radiate from the buried cable or pipe. In most cases these signals will enable the locator to pinpoint both position depth and current correctly.
- **Beware** – in some cases other factors will distort electromagnetic fields radiating from cable or pipe being located, resulting in incorrect information.
- **Always** locate responsibly, and use information learned during your training to interpret the information provided by the locator.
- **Do not** provide information regarding depth of cable or pipe to anyone unless authorized to do so by your company.
- **Remember** that depth measurements are to the center of the electromagnetic field or pipe – In the case of pipes this may be significantly deeper than the top of the pipe.

1.7 American & Canadian Safety Notices

USA

- This transmitter and receiver comply with the general conditions of operation, pursuant to part 15 of the FCC Rules.
 - CFR 47 Part 2
 - CFR 47 Part 15
- Changes or modifications not expressly approved by the manufacturer could void the user's authority to operate the products.

CANADA

- Equipment is for use by trained operators only, and not for general household or consumer use.
- Operation is subject to the following two conditions: (1) this device may not cause interference, and (2) this device must accept any interference that may cause undesired operation of the device.

EUROPE

- Vivax-Metrotech confirms that the location system is compliant with relevant provision of European directive 1999/5/EC.
 - ETSI EN 300 330-2
 - ETSI EN 301 489-1
 - ETSI EN 301 489-3
 - EN 55011
 - EN 61000-4-2: A1 & A2
 - EN 61000-4-3
 - EN 61000-4-8: A1

2. Service & Support

2.1 Serial Number and Software Revision Number

Always quote your receiver and transmitter model number, serial number and software revision number when requesting product support. They can be found as follows: (for reference only).



1	Model & Serial Number
---	-----------------------



NOTE

The transmitter model & serial number can be found at the bottom of the transmitter and also inside the transmitter between the battery tray and the main module of transmitter.

Software Revision Number: On both receiver and transmitter the software revision number can be found in the "About" section of the user menu.

2.2 Distributors and Service Centers Closest to You:

Worldwide Sales Offices and Service Centers	
World Headquarters, United State of America	Central/South America and the Caribbean
<p>Vivax-Metrotech Corporation 3251 Olcott Street, Santa Clara, CA 95054, USA Website : www.vivax-metrotech.com</p> <p>Sales & Sales Support: T/Free : 800-446-3392 Tel : +1-408-734-1400 Fax : +1-408-734-1415 Email : sales@vxmt.com</p> <p>Service & Repairs: T/Free : 800-638-7682 Tel : +1-408-962-9990 Fax : +1-408-734-1799 Email : service@vxmt.com</p>	<p>Ventas para América Latina 3251 Olcott Street, Santa Clara, CA 95054, USA</p> <p>T/Free : 800-446-3392 Tel : +1-408-734-1400 Fax : +1-408-743-5597 Website : www.vivax-metrotech.com Email : VentasparaAmericaLatina@vxmt.com</p>
	France
	<p>Vivax-Metrotech SAS Technoparc - 1 allée du Moulin Berger, 69130 Ecully, France</p> <p>Tel : +33(0)4 72 53 03 03 Fax : +33(0)4 72 53 03 13 Website : www.vivax-metrotech.com Email : salesfrance@vxmt.com</p>
Canada	United Kingdom
<p>Vivax Canada Inc. 41 Courtland Ave Unit 6, Vaughan, ON L4K 3T3, Canada</p> <p>Tel : +1-289-846-3010 Fax : +1-905-752-0214 Website : www.vivax-metrotech.com Email : CanadianSales@vxmt.com</p>	<p>Vivax-Metrotech Ltd. Unit 1, B/C Polden Business Centre, Bristol Road, Bridgwater, Somerset, TA6 4AW, UK</p> <p>Tel : +44(0)1793 822679 Website : www.vivax-metrotech.com Email : salesUK@vxmt.com</p>
Germany	
<p>Metrotech Vertriebs GmbH Am steinernen Kreuz 10a D-96110 Schesslitz</p> <p>Tel : +49 954 277 227 43 Email : salesEU@vxmt.com</p>	
International Distributors and Service Centers	
Australasia	China
<p>Vivax-Metrotech AUS Unit 1, 176 South Creek Road, Cromer NSW 2099, Australia</p> <p>Tel : +61-2-9972-9244 Fax : +61-2-9972-9433 Website : www.vivax-metrotech.com Email : sales@vxmtaus.com service@vxmtaus.com</p>	<p>Leidi Utility Supply (Shanghai) Ltd. No. 780, Tianshan Rd, Shanghai, China 200051</p> <p>T/Free : 4008-206-719 Tel : +86-21-5235-3001 Fax : +86-21-5235-8365 Website : www.leidi.cn Email : info@leidi.cn</p>

3. vLoc3-9800 Receiver

3.1 vLoc3-9800 Receiver Overview

The vLoc3-9800 is a precision location system designed to meet the needs of utility companies and their contractors. The following describes the features and use of the receiver:



1	vLoc3-9800 receiver
2	Mini-USB cable
3	Li-ion battery
4	Battery charger
5	6 x AA alkaline batteries
6	Alkaline battery holder
7	Power cable for charger *one of supplied based on geographical location
8	User manual
9	Soft kit carry bag



1	Pushbutton Keypad and Display	5	Mini-USB port data transfer and firmware updates
2	Model# & Serial#	6	Battery compartment cover
3	Battery retaining cover	7	Accessory socket and charging point
4	AA Battery Pack/Rechargeable Battery Pack	8	Expansion sockets for additional features such as the Bluetooth module

3.2 Charging the Receiver Batteries

The vLoc3-9800 can be used with either alkaline batteries or an interchangeable rechargeable battery pack.



The central illuminated section within the battery icon indicates the amount of charge remaining.

- Green center indicates rechargeable batteries
- Blue center indicates Alkaline batteries
- When batteries are low the charge remaining section becomes red and will flash

Just before shutdown the following symbol will be shown:



Rechargeable batteries are supplied with a mains charger. This is specific to the batteries, avoid the use of other manufacturers' chargers as these may damage the battery pack and may result in overheating of the battery pack.

To charge the rechargeable batteries, first make sure the pack is inserted in the receiver battery compartment as charging is done inside the receiver.



Connect the charger to the charging socket of the receiver. Connect the charger to the mains and switch on. The LED indicator on the charger will illuminate red until the batteries are fully charged at which time the LED will change to green.



WARNING

Rechargeable batteries are supplied with a mains or 12V DC charger. These are specific to the batteries. Only use the charger that is appropriate for the batteries in the product. If in doubt, call our customer service department at +1(800) 446-3392. Failure to use the appropriate charger could result in damage to the battery pack, locator and in extreme cases cause fire.

Avoid charging the unit in extreme temperature conditions. (i.e. below 0°C and above 45°C)

Although Vivax-Metrotech batteries include all the required safety related features, always immediately discontinue use of the charger and battery pack if the battery pack becomes excessively warm. Return both to where they were purchased for investigation.

Always ensure batteries have at least a partial charge if storing for long periods without use.

Dispose of all batteries in accordance with your company's procedures and or Federal/State and local regulations.

Never dismantle batteries, put them in fire, or get wet.

3.3 vLoc3-9800 Receiver Keypad

Keypad:

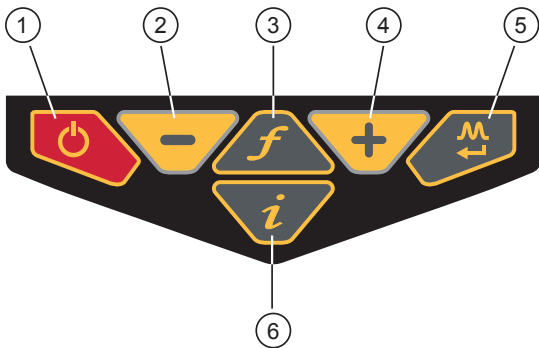

1	On/Off
2	Reduce sensitivity (Also scroll up when in User Menu)
3	Select frequency
4	Increase sensitivity (Also scroll down when in User Menu)
5	Short press = change antenna response Long press = change operational screen
6	Short press = enter information screen Long press = enter User Set-up options

The vLoc3-9800 has two main operational screens, "Peak Detect" and "Left/Right". These are described in detail later in the manual. The following describes the elements displayed on the screens.

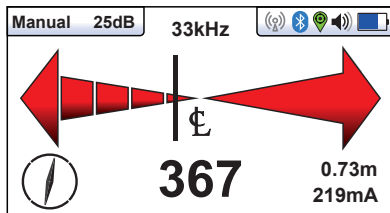



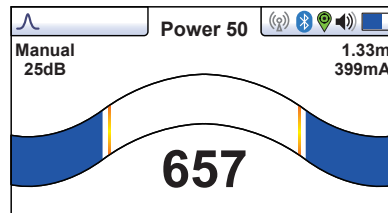

Left/Right Display



Peak Detect Display

Along the top right of the displays are the "Status" indicators. These appear at all times.

	<p>Battery Indicator. Blue = Alkaline Batteries, Green = Rechargeable batteries. When batteries are low, the symbol will have a red section and will flash slowly indicating the battery has a very low charge.</p>
	<p>Speaker volume indicator. Enter "User menu" to alter volume.</p>
	<p>GPS status Grey outline= No module or not activated Black outline = Module present but no valid data Green = GPS Data valid</p>
	<p>Blue tooth Icon Grey outline = No module fitted Black outline = Module fitted but not paired Blue outline = Module active and paired with a device</p>
	<p>Transmitter Link Grey outline = No module fitted or not activated Black outline = Module fitted but not linked with transmitter Blue outline = Module active and linked to transmitter</p>

Left/Right operational display elements:

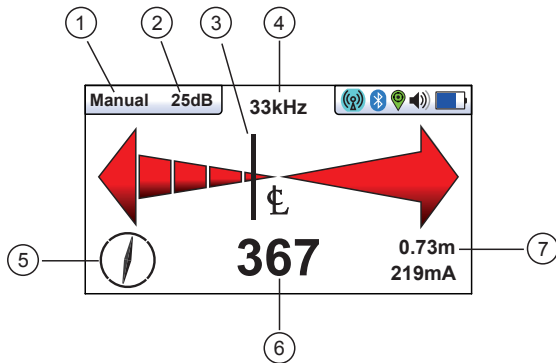

1	Auto/Manual Indicator
2	Sensitivity Setting
3	Moving Pointer
4	Frequency
5	Compass Line direction indicator
6	Signal Strength
7	Depth and Signal current indicator

Peak display operational elements:

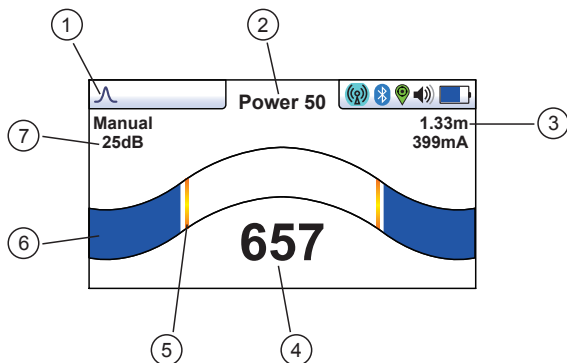

1	Antenna mode (In this screen this will always be "peak" mode)
2	Frequency selected Indicator
3	Depth and signal current indicator
4	Numeric Signal Strength
5	Peak Signal Strength indicator
6	Signal Strength indicator
7	Sensitivity setting

3.4 Setup Menu

The vLoc3-9800 has several features that can be switched on and off. These features are accessed through the user menu.

Switch on the unit by pressing and holding the On/Off key until the start-up screen appears. The start-up screen can be configured to the user's preference and is described later in the manual. Otherwise the start-up screen will default to the one below:



Access to the User Menu is via the "i" button. Press and hold down the button until the menu appears.

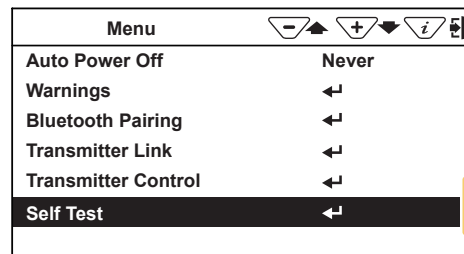
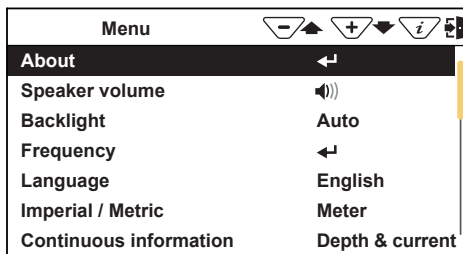

Note that the manual shows two screens but only one is shown on the vLoc3 display at a time.

Note that where you see this sign ← it means that pressing the enter button gives access to the sub menu associated with this button.

To exit the menu or sub menu, press the "i" button.

Where the ← icon is not shown, the enter button is used to scroll through the options of that feature.

The features are described below:

3.4.1 About

This section holds the data about the locator such as software revision, calibration data etc.

3.4.2 Speaker Volume

Press the enter button to scroll through the speaker volume settings.

3.4.3 Backlight

Press the enter button to change the backlight intensity setting. Note that high backlight setting will affect battery life.

3.4.4 Frequency

Use the enter key to enter the Frequency sub-menu. Scroll up and down the table using the "+" and "-" keys. The table contains all available frequency options. To simplify the operation of the unit, select only the frequencies applicable in your application. To do this use the enter key to check the boxes on the right. Frequencies not checked will not appear on the locate screen.

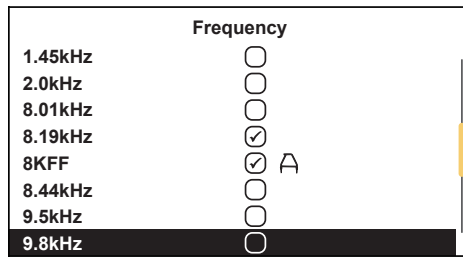

Note also that certain frequency options have an A-frame icon next to them. This indicates that these frequencies are selected to be used with the fault find A-frame.

3.4.5 Language

The unit may be supplied with different language options. Use the enter key to select the language of choice.

3.4.6 Imp/Metric

Select either Imperial or Metric measurements.

3.4.7 Continuous Info

The front Locate Screen can display a continuous reading of either Depth, Current, Both or can be switched off. Use the enter button to select your preference.

3.4.8 Auto Power Off

The unit can be set to switch off after a set time. Options are: 5-minutes, 10-minutes, or Never. Note that when the A-frame is connected the timer is set to "Never".

3.4.9 Warnings

Warnings relating to: - Shallow cable, Overload, Overhead cable and Signal Overload. Scroll down to the relevant warning and use the return button to select or de-select.

3.4.10 Bluetooth Pairing (optional feature)

Press the enter button to enter the Bluetooth pairing routine. This allows the unit to link with external devices such as dataloggers and GPS devices that have Bluetooth capability.

3.4.11 Satellite Info

Enter the sub-menu to see all the data relating to Satellite reception/data etc.

3.4.12 Transmitter Control

Enter the sub menu to gain information relating to the transmitter link status. For more information refer to section 6 relating to Loc3-10Tx.

3.5 Self-Test

The vLoc3-9800 has a self-test feature. The test confirms that the equipment is fit for use and calibration has not drifted from its expected settings.

To undertake the test, first find an area free from excessive interference such as overhead fluorescent lighting, large transformers etc. Also check that any nearby vLoc transmitters are switched off.

Select "Self-Test" from the user menu and press the "Return" button. The test will self-start. Keep the equipment stationary while the test is completed. After a short while the unit will report a Passed or Failed. Examples are below:

Self Test: PASSED		Self Test: FAILED	
	108.1 ✓ ✓ ✓ ✓		108.1 X X ✓ ✓
	63.1 ✓ ✓ ✓ ✓		63.1 X X ✓ ✓
	88.6 ✓ ✓ ✓ ✓		88.6 X X ✓ ✓
	87.0 ✓ ✓ ✓ ✓		87.0 X X ✓ ✓

If the unit fails the test, try again in a more interference free area. If it continues to fail, return the unit to Vivax-Metrotech or one of its approved repair centres for investigation and repair.

3.6 Warnings

Warnings are displayed in real time across the display as below:

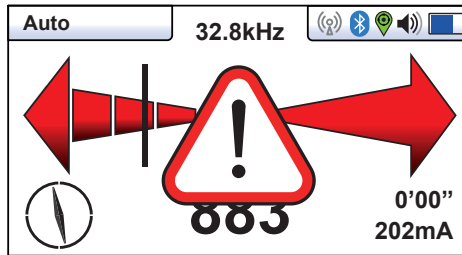

3.6.1 Signal Overload



This is a very unusual situation and is usually caused by operating very close to a power transformer or placing the unit right next to a transmitter in the Induction mode. Moving slightly away from the interfering signal will cure the problem. Signal overload will not cause damage to the instrument.

3.6.2 Shallow Cable



This indicates that the locator has detected a cable that is possibly less than 15cm deep. Proceed with caution.

3.6.3 Swing Alert



This indicates that the operator is swinging the locator excessively and could result in misleading information. When sweeping the locator across the direction of the line, try to keep it vertical. This will improve accuracy.

3.6.4 Overhead Cable



This indicates that the signal is mainly coming from above. This is usually caused by the signal travelling along overhead cables.

The warning symbols are accompanied by an audible sound and a vibration in the handle unless configured otherwise (See MyLocator3). Warnings can also be switched off in the User Set-up Menu.

3.7 Locating Mode

The vLoc3-9800 receiver has an array of antennas; these can be toggled through different modes to provide different responses to the signals radiating from the buried pipes and cables. Use a long press on the  button to toggle through the available modes. The modes are:

3.7.1 Auto Left/Right Mode (Active modes only i.e. not available in Power or Radio modes)

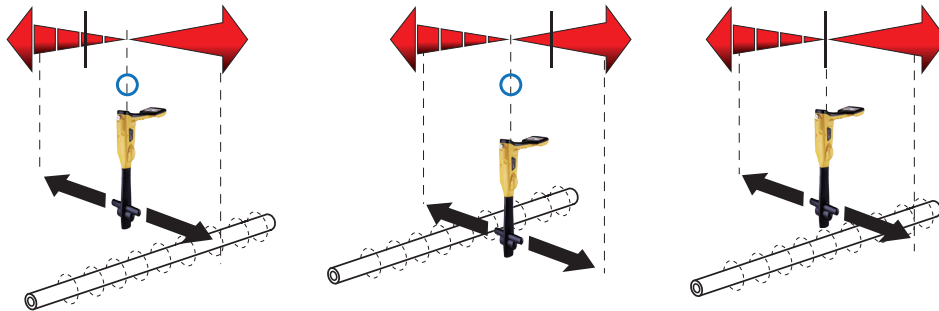
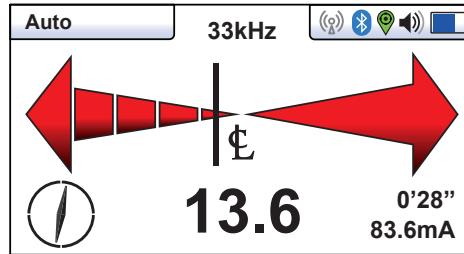

The Left/Right Auto mode is ideal when tracing long distance lines in less congested sites. It requires no user input to the keyboard allowing the operator to concentrate more on the safety of the surroundings.

A locate signal needs to be applied to the line and is described later in the manual.

As the locator is moved from left to right across the cable the moving bar will move accordingly. When the moving bar is exactly in the middle, the locator is directly over the target line. Try to keep the compass line indicator pointing "North/South" meaning the locator is orientated exactly along the line. At this point the numeric signal level will be at its highest.

This display is not available in the Power or Radio passive modes. Use Peak Display for passive modes.



NOTE

The speaker emits a pulsing tone while on one side of the line and is solid on the other. This allows the operator to easily judge the position of the line by the tone from the speaker. This allows operator to locate a line without having to watch the receiver display when walking along busy streets etc.

3.7.2 Manual Left/Right Mode (Active modes only i.e. not available in Power or Radio modes)

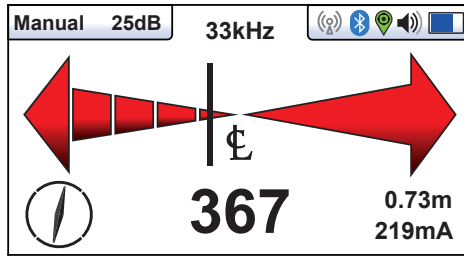

In the Manual Left/Right mode the sensitivity is set by pressing the “+” and “-” pushbuttons. The gain setting can be seen in the top left of the screen. This has the advantage of enabling the operator to adjust the sensitivity to signals from a deep pipe or cable. It can also be used to mask out the signal from an unwanted source.

To reject an unwanted signal, first set the sensitivity to a high value such that the unwanted signal is detectable. Sweep across the unwanted signal, reducing the sensitivity until the locate bar ceases to respond to the signal. Now double check that the wanted line is detectable. Keep the sensitivity at this setting and continue to locate the line.

This display is not available in the Power or Radio passive modes. Use Peak Display for passive modes.

3.7.3 Manual Peak Display Mode

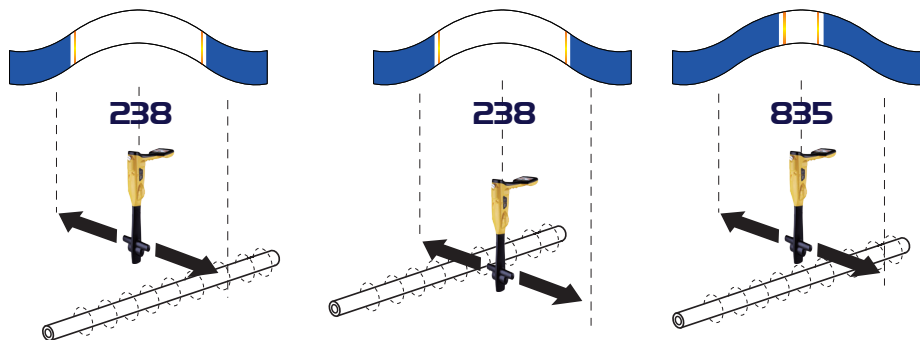
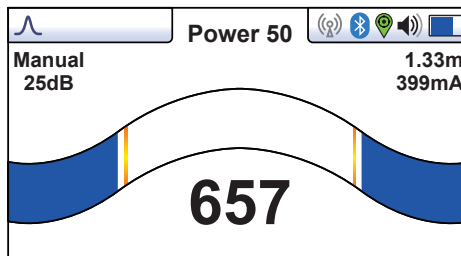

The Manual Peak Display mode is particularly useful in congested areas where there are multiple signals radiating from various lines. The sensitivity is set manually by pressing the “+” and “-” pushbuttons. As the locator is traversed across the target line the “curtains” of the bar graph will close. If the curtains are fully closed or fully open, one press of the “+” or “-” will bring the curtains back within scale. A numeric signal level is also displayed (999 represents full scale).

Use the red peak signal indicators on the bar graph to help identify the position of the peak signal.

This mode is also the default screen for Power and Radio passive Modes.

When using the manual peak display mode the relative signal levels become apparent, aiding identification of the target line.

The direction of the line can be determined by rotating the locator on its axis. When the signal is strongest the line is passing exactly forward/backwards.

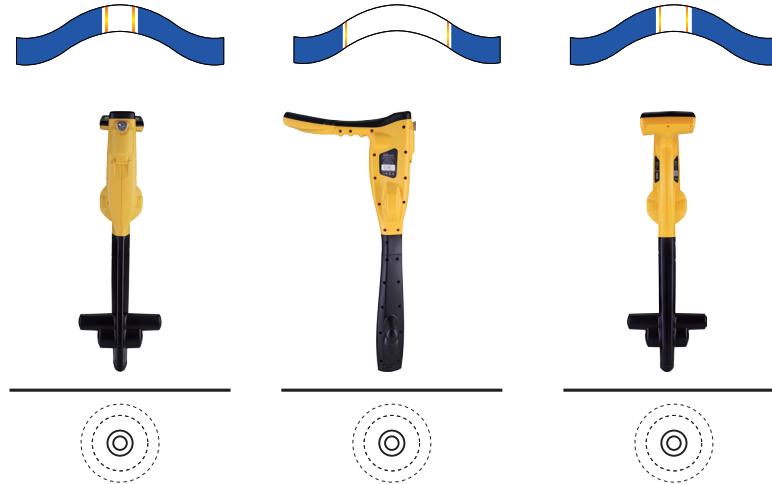

Notice also that if in an active mode and the locator is configured to do so, the depth and signal current are also displayed in the top right of the display. **1.33m**
399mA This information is only correct when directly over and correctly aligned.

3.8 Information Pushbutton - Depth & Current

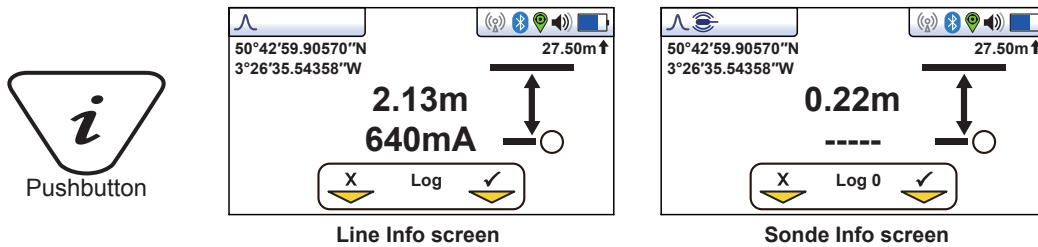

Pressing the “i” pushbutton will display the depth to the center of the radiated signal and a measurement of the current. Press the pushbutton briefly – remember if you press and hold, you enter the setup menu. If you do enter the setup menu, press the “i” pushbutton again to return to the locating screen then try again.

The accuracy of depth and current readings depends on the quality of the radiated signal being located. If the signal is not distorted, the depth reading will be accurate to within 5% of the actual depth. If the signal is distorted, depth readings will be less accurate.

If measuring the depth of a Sonde, ensure “Sonde” mode is selected otherwise the depth measurement will be incorrect. Sonde mode has a different “Info Depth” screen and does not indicate current.

The “Information” screen also indicates Longitude/Latitude and high above sea level co ordinates. This is only available if the Bluetooth option is installed, paired with an external GPS, and a valid GPS signal is detected.

Datalogging

It is possible to save the data on the info screen to the internal datalog. Pressing the “+” saves the data, pressing the “-” key rejects the data and returns to the locate screen. The number of logs stored in the device is also indicated.

Datalogging is described in more detail later in the user handbook.



IMPORTANT

When locating a cable or pipe, depth and current measurements should only be taken with the bottom of the receiver standing on the ground directly over and across the target line.

When locating a Sonde depth measurements should only be taken with the bottom of the receiver standing on the ground with the blade in-line with the Sonde.

3.9 Passive and Active Location

3.9.1 Passive Locating

Passive locating of buried utilities relies on electromagnetic signals created by currents that already exist on underground utilities. We group these under two settings:

- Power (P) – these are signals that generally originate from electrical power generation systems. These are around 50/60Hz and their associated harmonics.
- Radio (R) – these are signals that generally originate from low frequency radio transmissions. These are generally in the range of 16 kHz to 22 kHz.

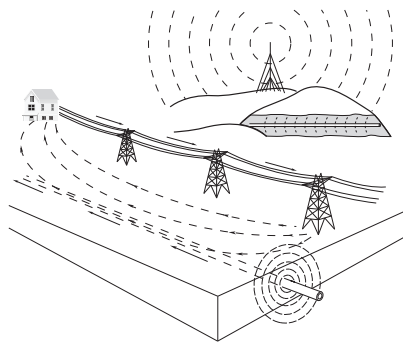

Passive location is used to search an area to see if buried metallic lines are present (known as locating to AVOID). It does not help to identify what buried pipe or cable is present, only to confirm that there is a pipe or cable there. For instance, it might be assumed that a signal being detected on the Power mode is radiating from a power cable, but in practice, for instance, this is sometimes from a pipe that has “stray” power currents travelling along it.

A typical application would be to check an area before installing a fence post.



NOTE

Passive locating can only be done in the Manual Peak Display mode.

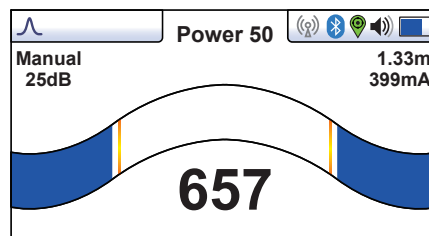

3.9.2 Active Locating

Active locating uses a transmitter to apply a very precise frequency to a pipe or cable. A receiver, tuned to that frequency, is then used to detect that signal. Active locate frequencies can be applied by direct connection, clamp or induction.

This transmitter can transmit a range of active frequencies.

The choice of frequencies, when using induction or the clamp, is restricted due to the requirement that these modes are optimised for a specific range of frequencies. The full range of frequencies is only available in "Direct Connection" mode.

For frequencies below 45 kHz, authorities such as the FCC allow higher power output to be used; for frequencies of 45 kHz and above, power output for this type of equipment is restricted to 1 watt. Therefore more power is available when lower frequencies are used.

3.10 Applying the Transmitter's Signal

The transmitter's signal cable is applied in any one of the three ways:

3.10.1 Direct Connection

This is used on pipes or cables that are not live and **do not** carry hazardous voltages. The "Direct Connection" mode will be selected automatically when the connection leads are plugged into the transmitter.

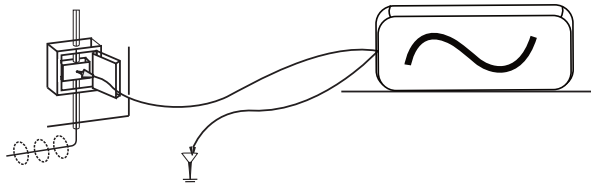

WARNING

Never make a direct connection to live cables carrying hazardous voltages.

Plug in the transmitter leads to the transmitter output socket.

Take the ground stake and push firmly into the ground. Connect the black connection lead to the earth stake.

Take the red lead and make the connection to the line.

Switch on the transmitter.

Caution

- Always make the ground connection first when connecting to the line. Always remove the ground last when disconnecting from the line.
- To make the signal travel further along the buried line, place the ground stake as far away as possible, and at 90° to the line. Where practical avoid having other buried lines between the ground stake and the target line, as this will reduce the chances of the transmitter signal coupling to another pipes or cables.
- Do not be tempted to connect the black lead to metallic items that may have an above or below ground structure, or to any other pipes or cables. Connecting to such items would cause signals to radiate from these secondary structures, which will increase the likelihood of an incorrect locate.



WARNING

There may be buried lines nearby when pushing the ground stake into the ground. Check using passive location prior to inserting ground stake. Stop if additional resistance is felt during insertion.

3.10.2 Clamp

This is used when applying the transmitter signal to cables carrying hazardous voltages, or cables where access to the metallic conductor is not possible, or desirable. The "Clamp" mode is selected automatically when the clamp is plugged into the transmitter.

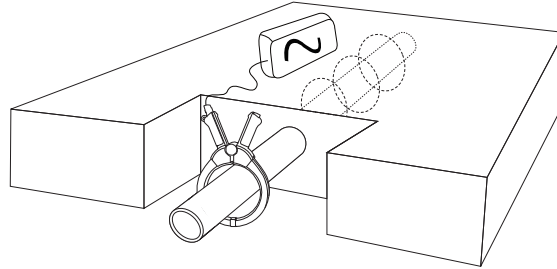

For a clamp to work efficiently the current induced by the clamp must flow along the buried line. Therefore, it is best if the buried line has a ground connection at both ends.

Plug the clamp into the transmitter before applying it to the target line. Open the jaws of the clamp, place around the target line, close the jaws. Be sure that the jaws of the clamp are completely closed. After applying the clamp, switch on and select the required frequency. Clamps are generally tuned to specific frequencies. Your transmitter only allows frequencies that are compatible with the clamp to be selected.

Note

The clamp works most efficiently if the two halves of the clamp close together correctly. Always check these parts for dirt or corrosion. However, if it is not possible to close the two halves, it may still be possible to locate the line as there will still be a small amount of signal induced into the line.



WARNING

Always follow the appropriate safety requirements mandated by safety legislation, safety practice or your company's safety procedures when applying a clamp to a cable.

Be aware that when placing a clamp around cables carrying high current or voltage, the clamp may vibrate, jump or close violently due to induced current from the target cable.

3.10.3 Induction

This is used when the direct connection leads, or clamp cannot be used. If no connection leads or the clamp is connected to the transmitter, "Induction" mode will automatically select.

An induction loop or coil is fitted inside the transmitter. The transmitter must be placed over the target line in a particular orientation, depending on the type of transmitter used. Check section 5.3.1 and 6.7 for more information.

Do not place the transmitter on a manhole cover, or any other metallic object, as that object will shield or detune the transmitter, resulting in little or no signal being induced in the target line.

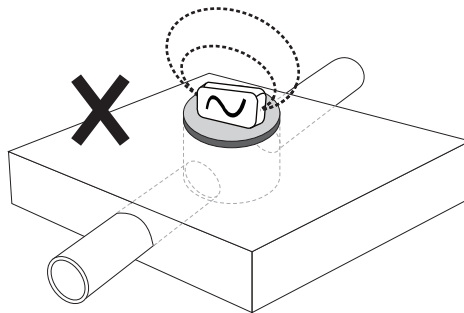

When using the "Induction" mode to apply a signal to a line, it is best that a minimum distance of 50ft (20m) is maintained. This is because the transmitter will transmit signal through the air which will interfere with signals from the cable, resulting in incorrect information. Locating closer is possible but measurements should be treated with caution.

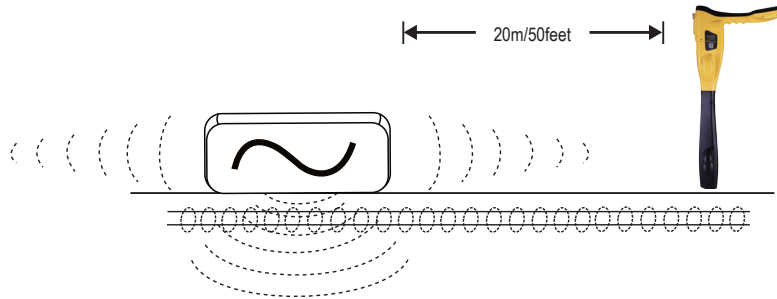

3.10.4 Searching an Area

In any given area, it is likely that buried pipes and cables are not parallel to each other, frequently they will cross the area being searched at a variety of different angles and depths. As the response of locator antennas is directional, it is important to search the area in the same or similar pattern as below. This orients the antennas in a way that will locate any signals being radiated from the buried line. Once a response is found trace and pinpoint the line and mark. Searching an area in this way is generally but not exclusively, done in the "Manual Peak Display" mode using passive locating.

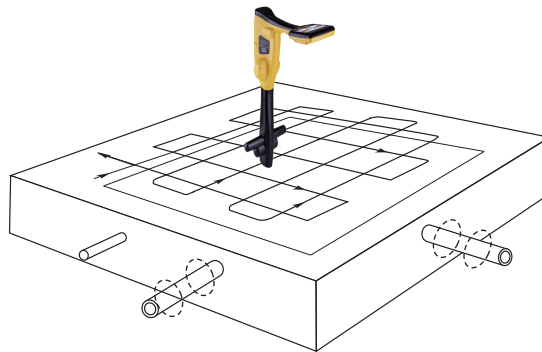

3.10.5 Tracing a Buried Line

Once a buried line is located it is generally necessary, and good practice, to trace that line for some distance in both directions. Whenever practical it should be traced to a point that provides additional confirmation of what type of service is being located - a telephone pedestal, a manhole cover etc. If tracing a line to which a transmitter signal has been applied, one should trace out from the transmitter connection point. The receiver should be held level to the ground and rotated in a small arc across the anticipated route of the buried line. A clear response should be visible on the display and heard audibly.

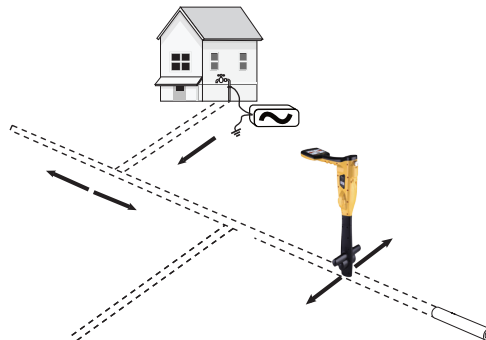

3.10.6 Pinpointing & Confirming the Buried Line

Marking the exact position of the buried line is generally called pinpointing. Pinpoint the line before marking its position. Place the receiver in "Manual Peak" or "Left/Right" mode, pass the blade of the receiver across the path of the cable and identify the position as indicated by the largest signal or as indicated by the Left/Right indicator. Use the "Compass Line Direction" indicator to confirm the line is exactly forward/back.

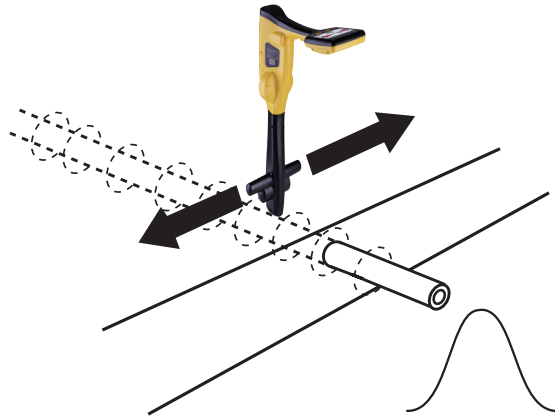

3.10.7 Measuring Depth and Current

- Pinpoint the cable as described in section 8.3.6, "Pinpointing & Confirming the Buried Line", with the receiver in line with and directly above the buried line – measure the depth (d) by pressing the "I" pushbutton briefly. Unless configured differently the current will be displayed at the same time as the depth.
- Be careful when locating in congested areas or close to bends or T's, they may be inaccurate due to distorted fields.

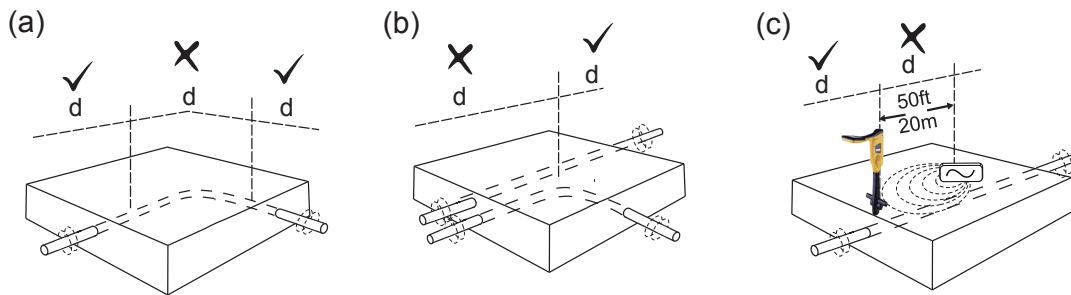

- An alternative method of verifying depth (illustration D below) is triangulation which can be done in the "Manual Peak" mode
 - Pinpoint the line as previously described. Adjust the gain so that full scale deflection is just achieved.
 - Move to one side until the meter deflection (using the numeric display may be easier) reads 70% (700).
 - Mark that position and repeat on the other side.
 - The distance between the two 70% marks will be the same as the depth to the line.

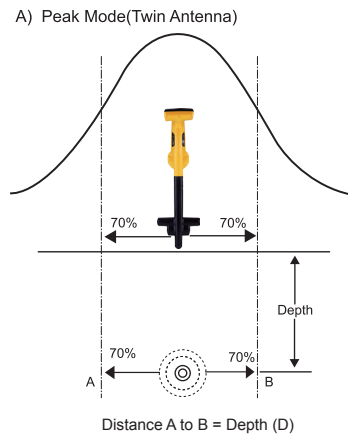

- Measuring the signal current.

Pinpoint the line as for measuring depth. The current can be displayed by briefly pressing the “i” pushbutton. Depth and current will be displayed, the signal from the transmitter will attenuate with distance. The further from the transmitter the less signal will radiate from the buried line. By locating at several points along the buried line you will identify an approximate rate of signal loss - beware that where a pipe or cable divides the signal will reduce more rapidly. If the signal current at the point you are pinpointing is different from what the trend would suggest, check to confirm that the correct cable is being located. To do this, return to a point where the current is as expected and very carefully trace the line to the new location checking regularly that the current has not changed significantly. A sudden change in current may be caused by straying onto an adjacent line.



WARNING

Never mechanically dig over the path of a buried pipe or cable. Always dig carefully and call before you dig.

3.10.8 Distorted Fields

The accuracy of measurements is affected by distortion of the signal being radiating from the target line. Distortion can be caused by stray signal currents leaking onto other lines or when the target line takes a sudden different course. One way to check for a distorted signal is to follow the procedure below:

To check if the signal is being distorted by other radiated fields. First locate the cable in the either mode.

- Place the locator on the ground and take a depth reading by pressing the “i” pushbutton.
- Note the result and then raise the locator approximately 1.5ft (0.5m).
- Take another depth reading and check the depth has increased by approximately this amount.
- If the depth has not increased by the correct amount, treat the results with caution.

3.10.9 Locating Non-metallic Pipes or Ducts

Locating non-metallic pipes or ducts is not possible using conventional locating techniques. However, it is possible to detect small transmitting devices (sondes) if they are inserted into a non-metallic pipe or duct. Sondes are available in a range of sizes and transmitting ranges. A popular one is the D38 Sonde that has a diameter of 38mm and a range of 5m.

The Sonde is typically attached to a drain rod (10mm fitting) and pushed down the pipe or duct and periodically located as it is pushed along.

Locating Sondes method:

1. Switch on the Sonde by connecting the battery. Connect it to the pushrod and place it in the start of the pipe run.
2. Switch on the vLoc3-9800 and select Sonde mode using long presses on the "Return" button. The Sonde icon will now be visible on the screen.

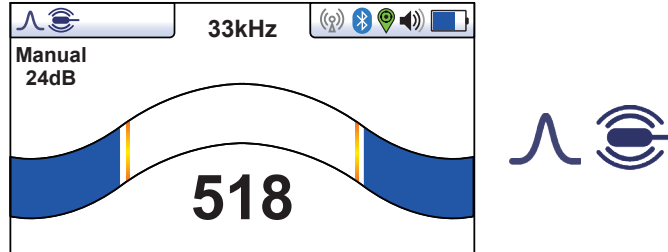

3. Position the vLoc3-9800 above the Sonde as indicated below: (The rotational orientation of the receiver is 90° to that used when line locating).

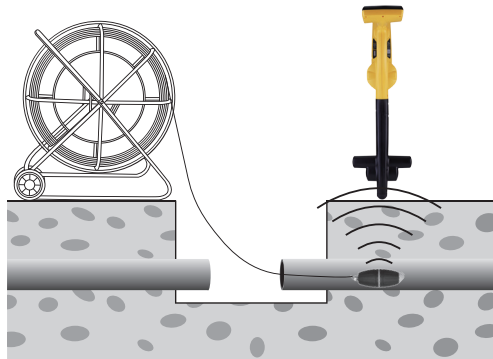

4. Adjust the sensitivity control so that the bar graph reads approximately 75%. Now move the vLoc3-9800 forward and back to detect the largest signal. You will also notice that there will be a "ghost signal" in front and behind the Sonde. This is normal and characteristic of locating Sondes.

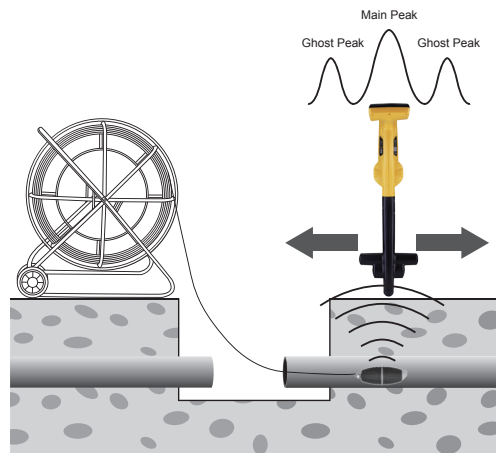

3 vLoc3-9800 Receiver

5. Now sweep left and right over the Sonde to obtain a second peak. Note that there are no ghost signals when sweeping left to right over the Sonde.

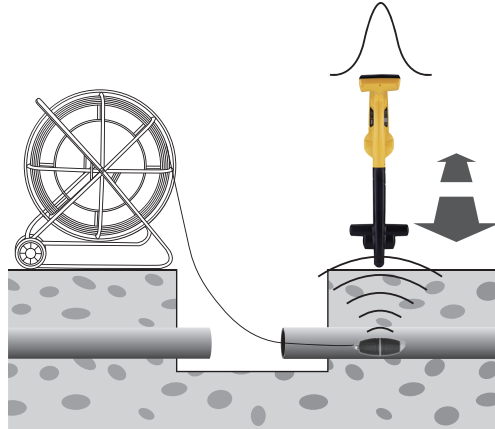

Finally check that the vLoc3-9800 is in line with the Sonde by rotating it on its axis to obtain a peak signal. The vLoc3-9800 is now over the Sonde and in line with it.

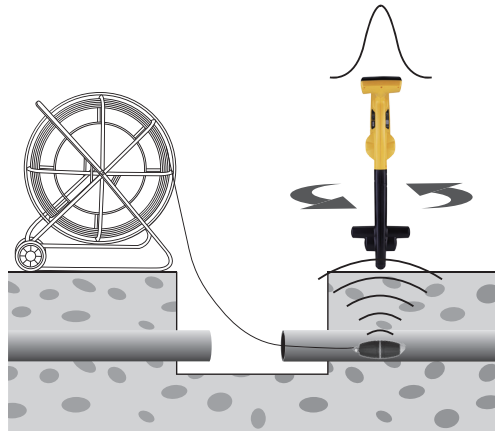

6. If a depth estimation is required, place the vLoc3-9800 on the ground having pinpointed the Sonde as above. Momentarily press the "I" button and the depth will be displayed. To exit the depth screen, either wait for the depth screen to "time out" or momentarily press the "I" button which will return the vLoc3-9800 to the locate screen.
7. Now push the Sonde in a couple of meters and repeat the above to mark out the route of the pipe or duct. Keep the insertion intervals small (2 to 3m) so as to ensure the Sonde is not lost.

4. Data Logging

The vLoc3-9800 has an internal memory that can be used to store locator data. Available storage size is 4 Gigabyte which relates to many thousands of records.

The records are user initiated. These are records stored by the user whenever the “+” button is pressed when in the “Information” screen.

Data can be stored relating to a standard locate or relating to any of the receiver accessories. (apart from the Remote antenna accessory).

In addition to this, every time a self-test routine is run the results are also recorded in the equipment. This is not a user-initiated record; it is done automatically after every self-test.

Warnings/Alarms are also automatically recorded.

To store a record first locate a point of interest. Hold the receiver stationary over the target and press the “i” pushbutton. When in the depth and current screen, press the “+” pushbutton to save the data. The “Log” number indicates the number of records stored. To exit the screen without logging the data, press the “-” button.

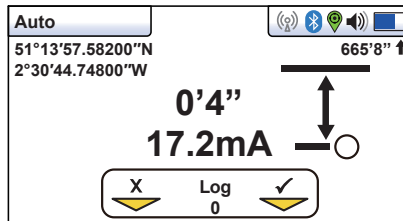

Note that current measurements are not shown in the information screen if in a Sonde mode.

If the following message is displayed:

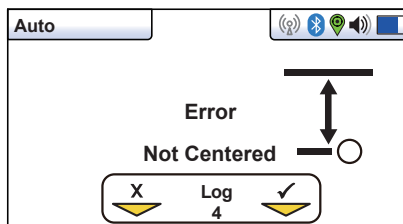

This indicates that the locate accuracy is not good enough. Return to the locate screen and repeat the pinpointing exercise and try again.

If the GPS function is enabled the GPS coordinates will also be displayed and attached to any saved file.

When the save button is pressed the log number will increase and the arrow below the check sign will turn green, indicating that the data has been stored successfully.

4 Data Logging

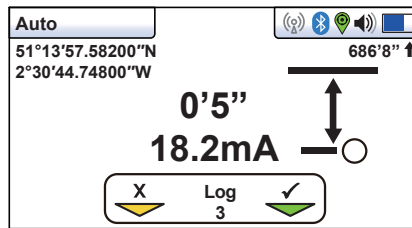

The screen will then automatically revert to the locate or accessory screen.

The data log can also be deleted from the info screen. From the info screen press and hold the “-” key. The message below will be shown.

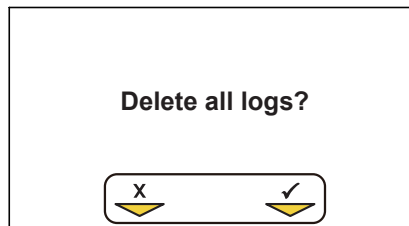

Press the “+” key to confirm. The locator will ask again “Are you sure?”. Press the “-” key to delete or the “+” key to cancel the deletion and return to the Locate/Accessory screen.

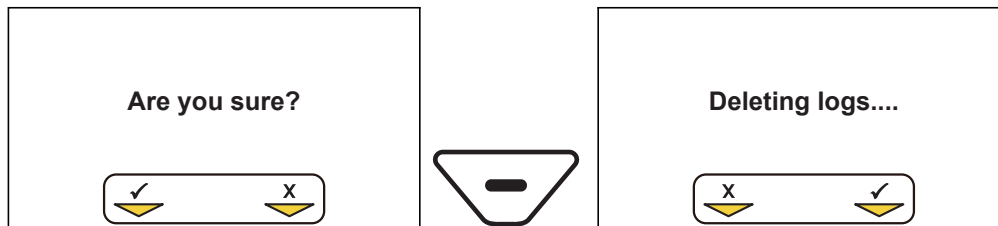

4.1 Bluetooth

As an option the vLoc3 range of receivers can be fitted with a Bluetooth communications module. This allows communication with external GPS and or Dataloggers. The Bluetooth option can be retrofitted and can be ordered at a later date if preferred.

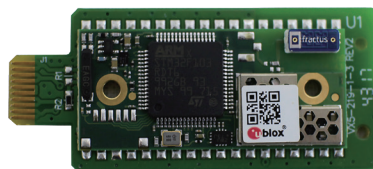

4.1.1 Fitting the Bluetooth Module

1. Ensure the unit is switched off.
2. Use a small cross head screw driver to remove the two screws retaining the Bluetooth cover. This is found on the side of the locator next to the display unit. Remove the cover by lifting it way from the unit.



4 Data Logging

3. You will see that there are two slots. The Bluetooth module fits in the larger of the two slots. The smaller of the two is not active and allows for future developments. Take the Bluetooth module and carefully slide it into position. Replace the cover and tighten the two retaining screws being careful not to over tighten.
4. Switch on the unit and after a few seconds a black Bluetooth icon should appear showing that the module is fitted.
5. If the Blue tooth icon is grey, this means the GPS option is not fitted or incorrectly fitted.
6. The Bluetooth can communicate with external devices that are also Bluetooth enabled. Generally, Bluetooth devices fall into two categories, high or low power devices. The vLoc3 Bluetooth is compatible with low power devices.

4.2 Pairing with external GPS/Dataloggers

To pair with an external device first ensure the Bluetooth option is fitted. This can be checked on the "Status" bar. If the Bluetooth icon is grey this means it is not fitted. Black icon indicates the option is fitted. The Bluetooth is retrofit table and is "Plug and Play".

Method

- Switch on the external device.
- Switch on the vLoc3-9800 and enter the User setup menu by a long press on the "i" button
- Use the "+" and "-" keys to scroll down to the option "Bluetooth Pairing"
- Press the Enter key
- Press the Enter key to commence "Bluetooth search"
- A list of available devices will be shown
- Scroll down to the desired device and press the Enter key.
- Double press the "I" button to return to the main screen
- After a few seconds the Bluetooth icon should turn blue indicating the device has paired successfully
- The unit will remember the pairing even after switching off. However, the unit can only remember one unit at the time so if the unit is paired with another device the settings will be forgotten.

GPS (Global Positioning System)/GNSS (Global Navigation Satellite System).

The vLoc3-9800 can utilize location data an external GPS/GNSS. The vLoc3-9800 needs to be paired with an external device (See previous section on Bluetooth devices).

- Pressing the "I" button to enter the depth screen will now also show the GPS data (as long as a valid GPS signal has been detected) Numbers on the left-hand side are Lat and Log coordinates and the numbers on the right indicate height above sea level.

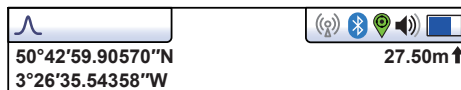

4.3 Transferring Data from the Locator to a Computer

To transfer data it is necessary to use the vLoc3-9800 Configurator Tool called Mylocator3. This is a simple program that can be downloaded from the Vivax-Metrotech web site at www.vivax-meterotech.com.



TIP

To view Google files it is first necessary to install the Google earth application to your computer. This is a free application which can be found at <http://www.google.com>

4.3.1 MyLocator3

This section describes the user operation of the MyLocator3 PC application.

MyLocator3 is a desktop PC application which is capable of downloading code and configuring the vLoc3 series of locators.

The first part of this document (Basic Operation) describes usage not requiring a USB security dongle. The second part of this document (Advanced Features) describes usage requiring a security dongle.

MyLocator3 is a free download App available at www.vivax-metrotech.com.

Follow the instructions to download and install the application.



MyLocator3

A “MyLocator3” icon will appear on the computer desktop.

Connect your vLoc3-9800 to your computer via the mini USB connector which can be found under the battery cover flap.

Launch MyLocator3 by double clicking on the icon.

4.3.2 MyLocator3’s Basic Operation

MyLocator3 operation, not requiring a USB security dongle.

4.3.2.1 Updates Page

When a locator is first connected to the PC, the “Updates Page” will be displayed and this will show the locator variant type along with the locator serial number and the running firmware version in the upper left-hand box. The upper right-hand box will show information about the MyLocator3 PC application.

Clicking on the clock symbol sets the locator time to UTC time. To check local and UTC time, hover over the icon and the times will be displayed to the right, flashing alternately.

MyLocator3 can also be viewed in a number of language options. Click on the pull-down menu to select the desired option.

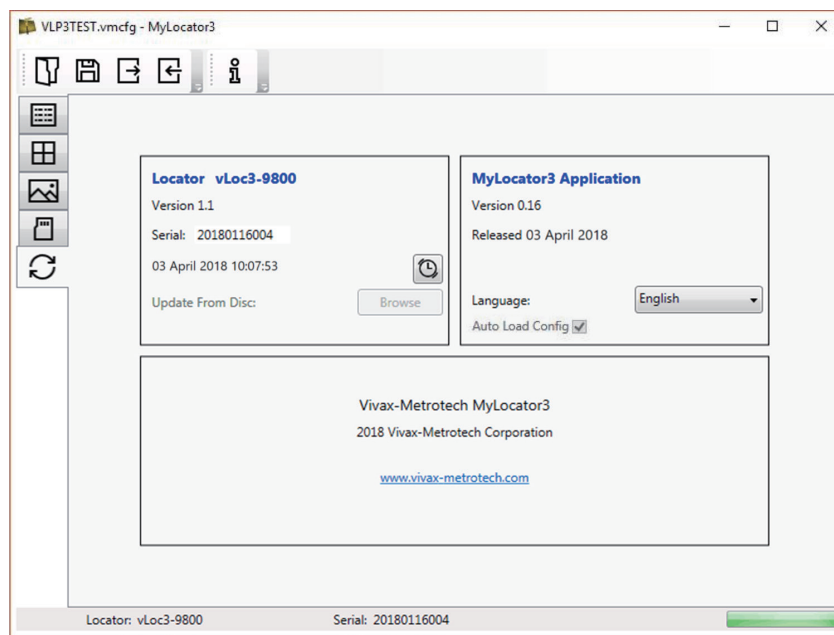

4.3.2.2 Application Update

Every time the MyLocator3 Application is started its version number is checked against the latest version available on the Vivax-Metrotech server and the user is notified if an update is available as shown below. This feature will only be available if the computer is “on line”.

Clicking on the “Update Now” button will download the latest version from the Vivax-Metrotech server which can then be installed by the user.

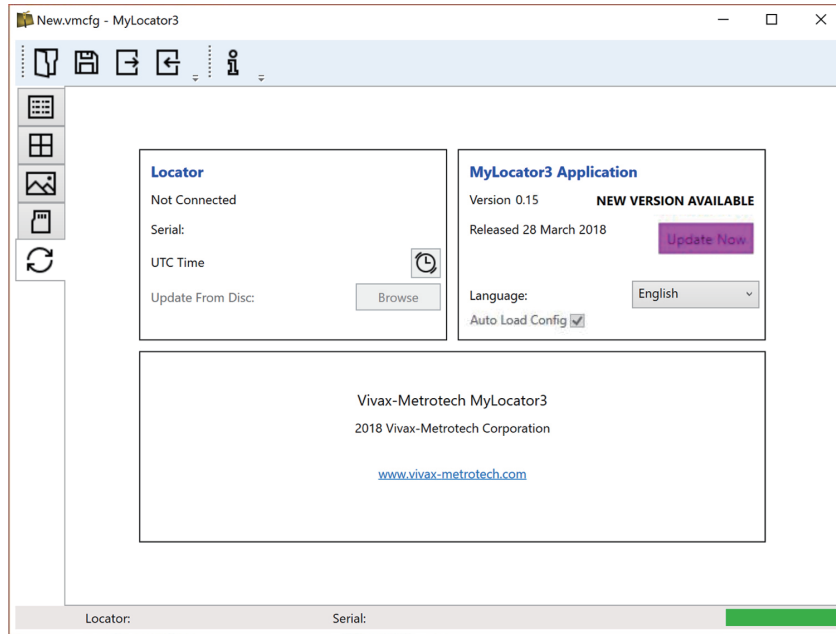

4.3.2.3 Locator Firmware update

Each time a locator is connected to the PC, its firmware version is checked against the latest version available on the Vivax-Metrotech server and the user is notified if an update is available as shown below. This feature will only be available if the computer is “on line”.

Clicking on the “Update Now” button will search for the latest version from the server and then download it to the locator.

The “Update From Disc” feature will only be available if a suitable dongle is also attached to the PC. This feature allows the user to install older versions of firmware stored on the computer, although it is advised that only the latest version of firmware is used.

4 Data Logging

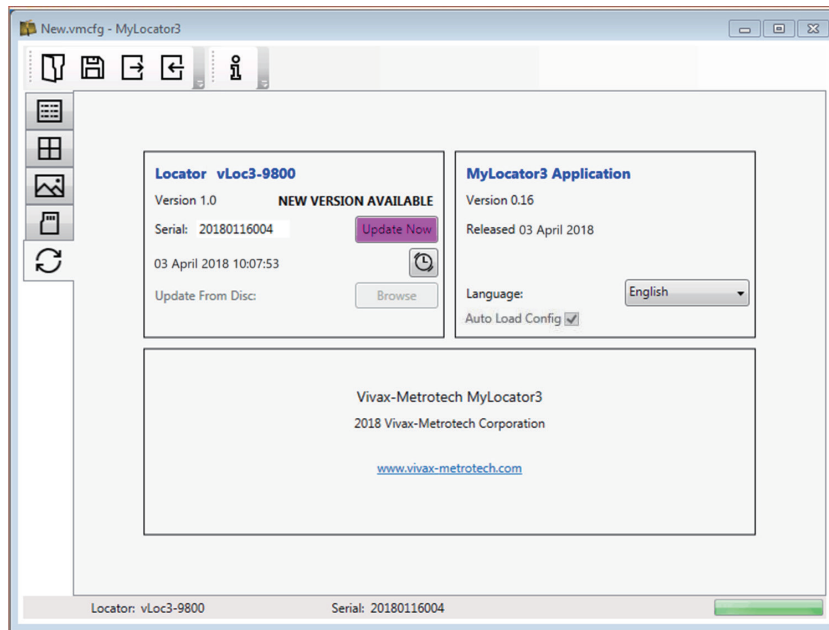





4.3.3 Toolbar

The vLoc3-9800 locator can be configured so that features can be switched on or off. This enables the user to tailor the instrument to meet the needs of their application while keeping the user interface uncluttered. The toolbar at the top of the screen enables the user to create configurations.

The application toolbar looks like this:



	This will open an existing configuration file (*.vmcfg).
	This will save the configuration to a file.
	This will write the configuration to the connected locator.
	This will read the configuration from the connected locator.
	This will display information about MyLocator3.

4.3.4 Data Logging

Clicking on the Data Logging tab will display information about the state of the attached locator's data log contents. The data log contents can be stepped-through by using the controls on the left-hand side. The user can upload a selection of logs from the locator to the PC by using the controls in the upper right-hand side.

The data in the datalog can be configured before exporting. The parameters that can be set are:

- Distance units
- Date format
- Time format ie UTC or local time.

Files may be exported/saved locally as .csv/.bin/.kml/.shp files and examined later. The default filename is based on the serial number of the connected locator but can be changed during the saving process.

Tip

If it is only required to export a portion of the log (for instance, a survey on a particular day) use the data log scroll facility at the bottom left of the display, to scroll through to the start date/time. Note the log number and then scroll to the end date/time and note also this log number. Use these numbers to enter the "From" "To" numbers in the top right of the display when exporting. This will help to keep the exported data to a manageable size.

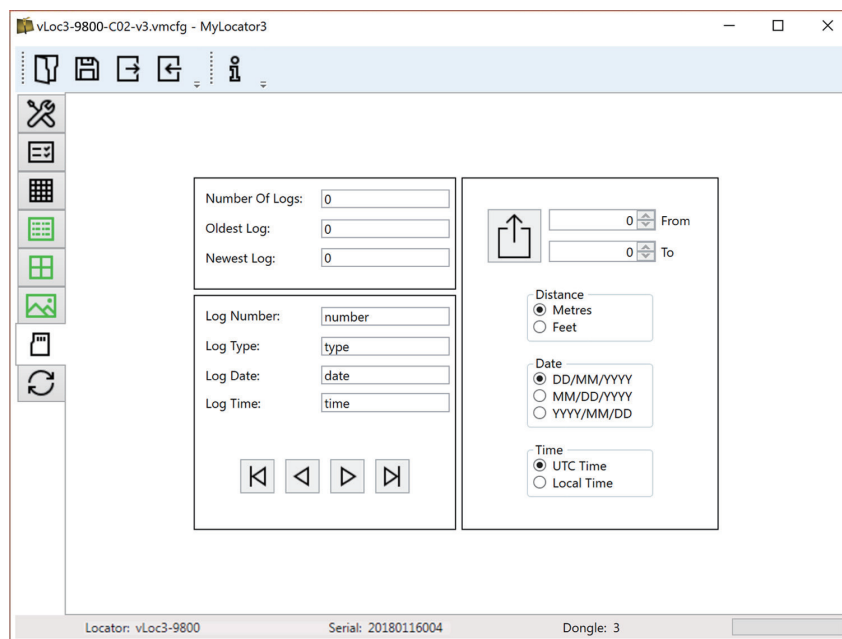

4.3.5 Splash Screen

On this page an image can be loaded which can be used as a splash screen by the locator when it is switched on. The locator has an LCD screen with a resolution of 480 by 272 pixels. The image loaded into MyLocator3 will be scaled to fit the width of the screen. If the scaled image height is less than the LCD height, then the image is centered vertically and white bars are used as padding. If the scaled image height is greater than the LCD height, then the image can be re-positioned vertically by clicking and dragging the left mouse button anywhere on the image.

To insert your own start-up screen first click on the "Open" button. Then browse your files to select the picture required as the startup screen. The application is compatible with file formats .jpg/.bmp/.png/.gif.

4 Data Logging

The start-up screen will be displayed in the application.

The **Download** button can be used to set the splash screen immediately or the image can be sent to the locator along with the rest of the configuration by pressing the "Write Configuration" button.

To remove a start-up screen and revert to the default Vivax-Metrotech screen click on the "Clear" button and download the cleared screen.

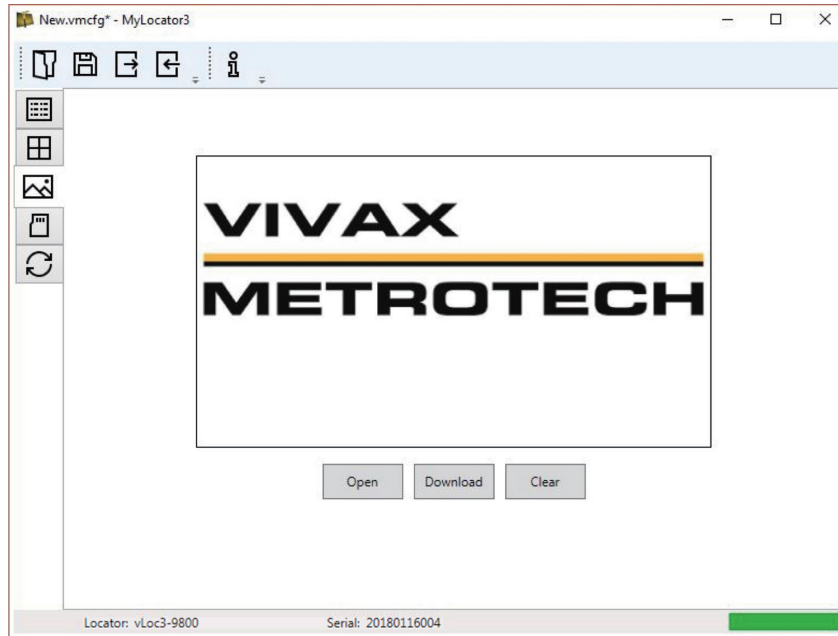

4.3.6 Frequencies Page

The Frequencies page will allow the user to refine which frequency modes are available when the locator F-key is pressed and which frequencies appear on the locator menu.

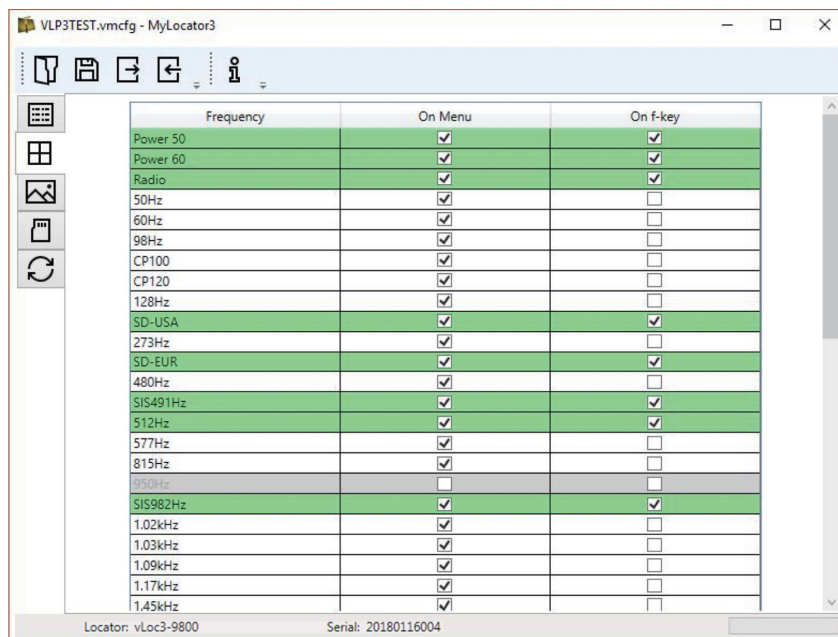

4.3.7 Menu Settings

The **Menu Settings** page allows the user control over which menu items appear on the locator and also the initial setting of the menu item when the locator is first used after configuration.

The menu items with a right pointing arrow  can be expanded to reveal further sub-menu items. If the **On-Menu** item is ticked then the item will appear on the locator menu. The item displayed in the **Setting** column will be the initial locator setting after configuration. If the **Setting** value is not selected then the locator setting will be unchanged.

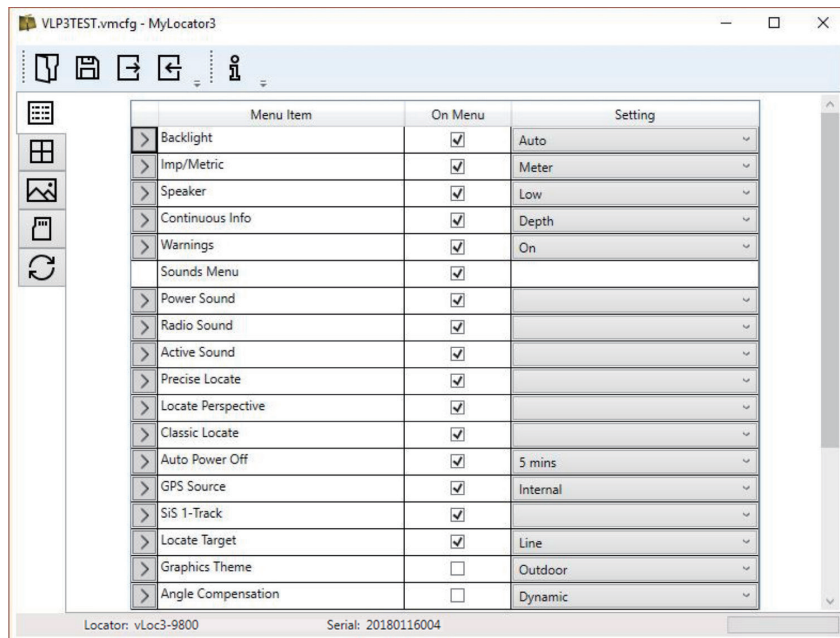

4.3.8 Advanced Features

The Advanced Features are available to those users in possession of a USB security dongle. If a dongle is attached to the PC then its level will be displayed on the MyLocator3 status bar.

4.3.8.1 Supervisor Lockouts

This feature is available to anyone with a dongle, contact Vivax-Metrotech, or your local distributor for the purchase of a dongle. When a dongle is connected to your computer via a standard USB socket, the icons for the Splash Screen page, Frequencies page and Menu Settings page will change color to green. This color indicates the page is unlocked.

The Splash Screen page, Frequencies page and Menu Settings page can each be individually locked by double-clicking on their page tab icon. If a page is locked then it can only be accessed by a user with an appropriate security dongle. This will prevent unauthorized users from changing protected locator items.

The page tab icon will change color from green to amber.

To unlock a tab, with the dongle connected, double click on the tab to unlock.

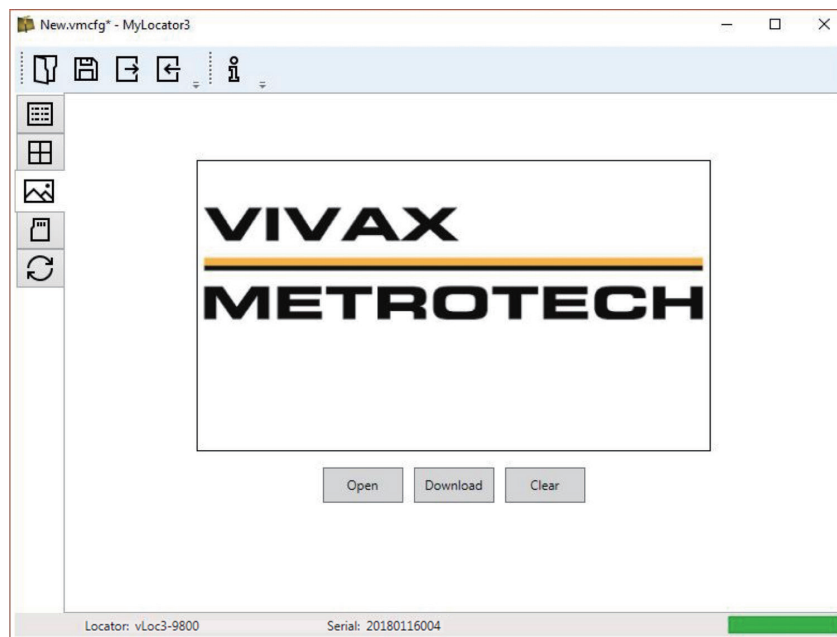

5. Loc3-10Tx Transmitter

5.1 Loc3-10Tx Transmitter Overview

The Loc3-10Tx transmitter is a rugged portable transmitter powered by alkaline “D” cells or Li-ion rechargeable batteries. The following describes the features and uses of the transmitter.



5.1.1 Display

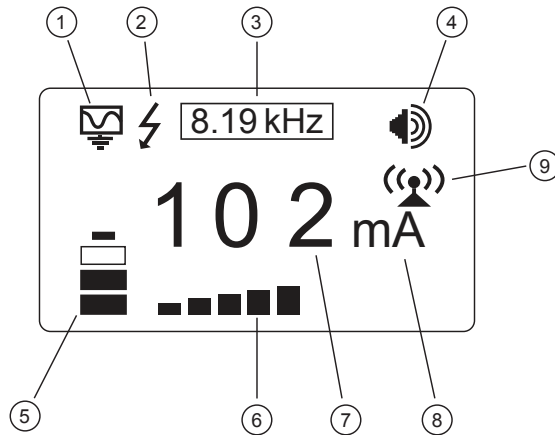

1	Mode Indication Icon	6	Output Setting (Step) (filled box indicates current level has been reached, empty box indicates requested current level has not been achieved)
2	High Voltage Warning* (output is enabled for high voltage)		
3	Frequency Being Transmitted	7	Digital Read Out (mA, volts, ohms)
4	Loudspeaker Level	8	Units (mA, volts, ohms)
5	Battery Status	9	Blinking icon = Tx-Link is not paired Solid icon = Tx-Link is active and linked to transmitter

***External Voltage Warning**

The transmitter checks the line when connected. If the line is carrying voltages in excess of 25V, it will display the “high voltage” warning icon and not allow the transmitter to operate. In addition the transmitter is protected by a 1.5A/250V fuse in the event of excessive voltage or voltage spikes on the line.

5.1.2 Pushbuttons

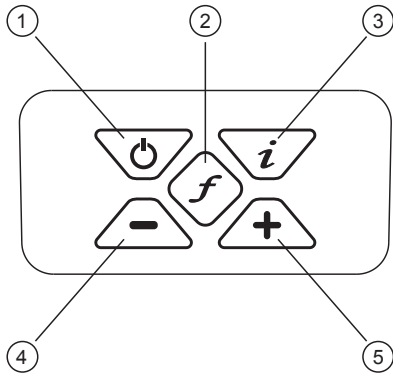

1	On/Off Control
2	Frequency Select
3	Information (Volume, Volts, Ohms, Multi Frequencies LCD Contrast, Bluetooth Menu, Frequency Menu)
4	Output Decrease/Navigate through menu
5	Output Increase/Navigate through menu

5.1.3 Information Pushbutton

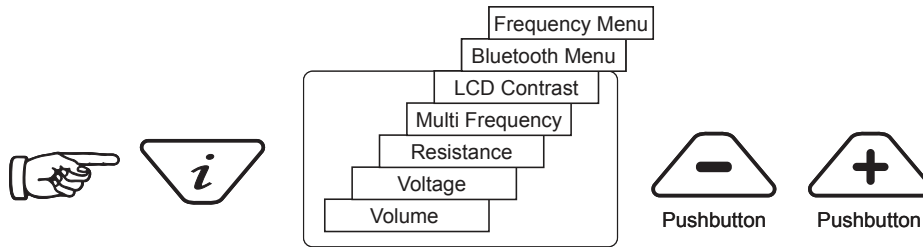

When the “i” (information) pushbutton is pressed, the display will show the volume level of the audio; use the “+” and “-” pushbuttons to increase/reduce the volume or turn the beeper off (off – low – medium – high).

Keep pressing the “i” (information) pushbutton, the display can be toggled to show “voltage”, “resistance” or other functions as shown in the drawing above. The display indicates mA, as the default, and volts or ohms when selected.

NOTE: The number of “i” button presses, and available sub-menus will vary with the mode the transmitter is.

5.1.4 Connections Block

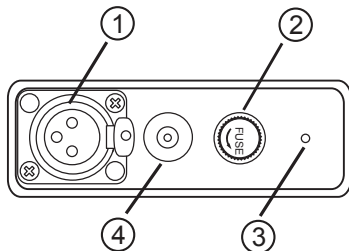

1	Output connection
2	Output Protection (Fuse)
3	Loudspeaker
4	Battery Charging Socket & DC Input

All the connections made to the transmitter are made at the connection block except for a USB socket which is mounted inside the battery compartment and is used for the transmitter’s software upgrade.

5 Loc3-10Tx Transmitter

The connection block consists of:

- Output (XLR) socket – for the direct connection lead and clamp.
- Charger socket (to charge rechargeable battery pack – the charging socket is present even if rechargeable batteries have not been purchased).
- Transmitter 12V DC power lead used to power the transmitter from a vehicle and if rechargeable batteries are fitted, will charge the transmitter at the same time.
- Fuse – this protects the transmitter circuitry in the event of the transmitter receiving up to 250V incoming voltage on the output leads, or higher than allowed current.
- A beeper is positioned behind the small hole.

5.2 Transmitter Battery



In most markets the transmitter is shipped with alkaline batteries (12 x D cells) unless rechargeable batteries are specified. The battery status is displayed on the left side of the display.

The letters "LP" will appear when the battery status reaches only one bar. At this battery level the max output current and power is limited.

The Li-ion batteries can be charged either through the socket on the side of the transmitter or an internal socket which is accessible only when the pack is removed from the main body. In either case the charger is the same.

Internal Charger Socket



WARNING

Only use a charger supplied by Vivax-Metrotech Corp. Using non-approved chargers may result in damage to the equipment or overheating/explosion.

The battery condition (charge) is displayed on the left side of the display.

5.2.1 Removing the Battery Tray

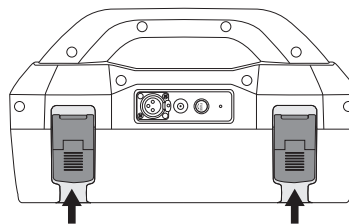

Pull out bottom of catch

5.2.2 Replacing the Alkaline Battery

- To access batteries – put a finger underneath each battery clip. Apply an upward and outward pressure to release each catch.
- Replace batteries with new batteries of the same type, be sure not to mix old and new batteries.
- Do not use rechargeable batteries in the alkaline battery tray. Ensure that batteries are inserted the correct way (see label and molded "+" and "-" in the bottom of the tray).



WARNING

Alkaline Batteries – insert alkaline batteries (x12) as shown:

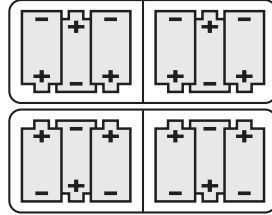

5.2.3 Rechargeable Batteries

- **Do not** attempt to replace the rechargeable batteries or remove battery covers – return to Vivax-Metrotech or a Vivax-Metrotech approved service centers for replacement.



WARNING

Use only Vivax-Metrotech recommended charger.

5.2.4 Re-fitting the Battery Tray

To close the battery tray – slide the transmitter (TX) onto tray, it will locate itself in the correct position, then close the catches.

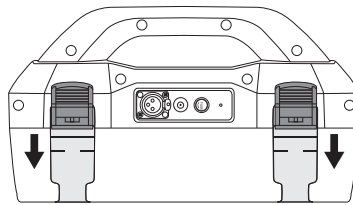

Push up button underneath the catch – where holding that up push in the bottom of the catch. You will hear a positive “click”.

5.2.5 Rechargeable Battery Pack Charging and Disposal

Follow instructions detailed in the General Safety & Care Information section of this document.

Only use the battery charger supplied. Using a non-approved charger may damage the battery pack and could cause overheating.

To charge, the rechargeable batteries pack must be connected to the transmitter. Connect the mains charger to the charging socket on the side of the transmitter and connect the charger to a suitable mains socket. Or if needed rechargeable tray can be charged independently.

The LED on the charger will show a red light indicating that the charge cycle is in progress. When the batteries are fully charged the LED will change to green.



NOTE

Rechargeable pack cannot be charged from a 12V DC source.

5.3 Transmitting Modes

The transmitter has three transmitting modes, which are selected automatically.

5.3.1 Induction Mode

This uses an internal antenna to induce a locating frequency onto the target pipe or cable (line). “Induction” mode is automatically selected if no connection accessories are plugged into the “output socket”. An icon indicating “Induction” mode shows on the display. The icon flashes when the transmitter is transmitting. In order to generate successful induction, the transmitter should be positioned over and with the handle in line with the target line.

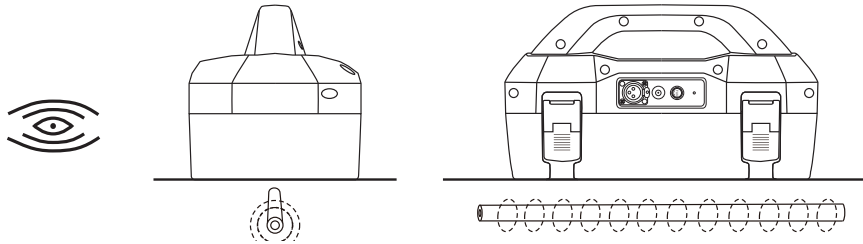

“Induction” mode is generally used when no access is available to make a direct connection, or a clamp connection. When using induction it is very likely that the signal being induced onto the target line will also be induced onto other lines in the area, and onto above ground features such as wire fences. This can influence the accuracy of the location, depth and current measurements. “Induction” mode is also the least efficient way of applying the transmitting signal to the target line. The distance located with “Induction” mode is generally much less than that achieved with a direct connection or clamp connection. The “Induction” mode is only available from 8kHz and above.

Induction frequencies are available based on the user selection. See section 5.4.2, for information relating to “Most Used Frequencies (Frequency Selection) Feature”, for adding and removing frequency from the favorite frequencies list.



NOTE

For accurate location and depth measurement the locator receiver should be used no closer than 50ft (20m) from the transmitter.

5.3.2 Direct Connection Mode

“Direct Connection” mode is automatically selected by plugging in a connection lead to the output socket. An icon confirming this is shown on the display. The wave in icon fluctuates when the transmitter is transmitting. The direct connection lead consists of two cables, one (red clip) must be connected to the conductor being located, the other (black clip) to a suitable ground (a ground stake is provided with the transmitter). A ground extension spool is also supplied. If the ground extension spool is used, the ground clip of the connection lead (black clip) is attached to one end of the auxiliary ground lead.

A good connection is indicated by a change in beep rate from the speaker and the current reading on the display.

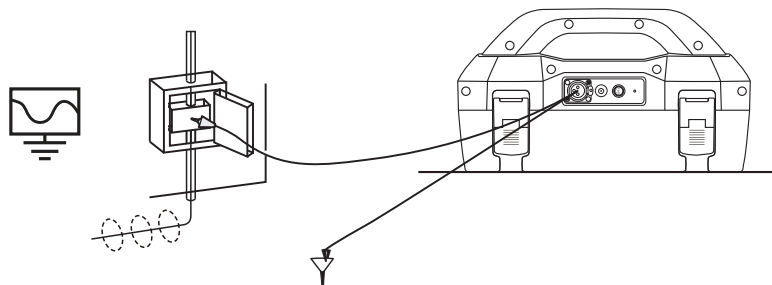

5 Loc3-10Tx Transmitter

Wherever a direct connection can be safely made without the risk of injury, damage to customer's plant, or the transmitter, it is the best way of applying the transmitter's signal.

The coupling of the transmitted signal to other pipes and cables in the area will be much less than with induction, although where commonly bonded systems are encountered – coupling cannot be avoided.

The positioning of the ground connection can also influence the degree of coupling experienced. Ground connections generally should not be made to other pipes or cables, or above ground metallic structures such as wire fences. In general the lower the frequency is, the further the signal will travel, and the less signal coupling will occur. The most common frequencies used for direct connection are between 512 Hz/640 Hz and 8 kHz.

Regulations in many countries require that power output is limited above certain frequencies. The Loc3-10Tx enables frequencies below 45 kHz to be transmitted using as much as 10 watts output, but frequencies over 45 kHz are restricted to 1 watt. Using direct connection and the higher power at the low frequencies helps significantly in achieving greater location distances. Direct connections should not be made to cables carrying greater than 25V (or as your safety practices allow). The transmitter is protected (250V fuse) from stray currents that may exist on the target line.

5.3.3 Clamp Mode

Plugging the signal clamp supplied by Vivax-Metrotech into the output socket will place the transmitter in "Clamp" mode. An icon confirming this is displayed on the display. The icon flashes when the transmitter is transmitting. When using the clamp no ground connection is needed.

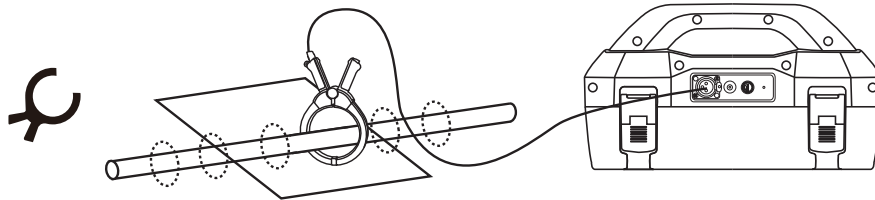

The clamp again is also a precise way to apply the locating signal. It is generally used when it is not possible to access the conductor to make a direct connection (but there is sufficient access to place the clamp around the cable), or when it is not safe to make a direct connection because the target cable is carrying electricity.

The clamp is a specialized inductive device (sometimes known as a toroid or coupler). All clamps are optimized to work at specific frequencies. In most cases clamps are designed to be used at frequencies generally between 8 kHz and 200 kHz. The transmitter will only allow the selection of a suitable range of frequencies for your clamp.



WARNING

When applying the clamp to cables that carry electricity – be sure to follow your company's safety instructions and procedures. Beware that if applied around a high voltage cable – that cable may induce a current in the clamp causing it to snap shut or jump quite dramatically – always apply clamps carefully.

5.4 Frequencies

5.4.1 Frequencies and Power Output

The Loc3-10Tx transmitter is supplied with a predefined set of transmit frequencies. The most commonly used frequencies will be preset by the factory. Additional frequencies are available to be select in the frequencies list see section 5.4.2.

Example of standard frequencies/preset at the factory are:

- 512Hz (where electrical systems are 60Hz) direct connection – 10 watts.
- 640Hz (where electrical systems are 50Hz) direct connection – 10 watts.

5 Loc3-10Tx Transmitter

- 8 kHz direct connection – 10 watt
- 33 kHz direct connection – 10 watt
- 65 kHz direct connection – 1 watt.
- 83.1 kHz, 131 kHz direct connection – 1 watt (depending on region).
- 200 kHz direct connection – 1 watt (depending on region).
- Some other frequencies with 10 Watt output:
 - Direct connection: 256Hz, 491Hz, 982Hz, etc.
 - Direct and clamp connection: 8.19 kHz, 8.44 kHz, 9.5 kHz, 9.82 kHz, 32.8 kHz, 38 kHz
- Some other frequencies with 1W output: 89 kHz, 131 kHz, 200 kHz
- Clamp connection: any frequency from 8 kHz up to the highest allowed frequency (depending on region).
- Induction Frequency: this transmitter is a broad-band induction unit. It means that user can select for the Induction mode any frequency he wants, from 8 kHz up. (highest available frequency depends on region)

NOTE: See section 5.4.2 for frequency activation procedure.

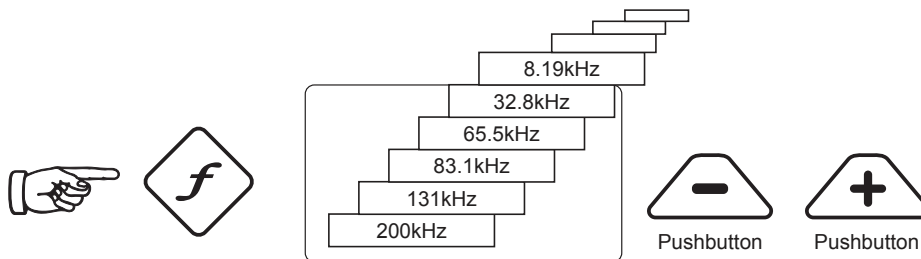

As with most manufacturers the clamps and induction antennas are tuned to specific frequencies, and **do not** work over the complete range of frequencies.

Frequencies are selected by pressing the “f” pushbutton which toggles through the available frequencies for the selected mode. The frequency is automatically selected if you don’t toggle past it within two seconds. The frequency is shown on the display.

NOTE

The output current is shown in large characters on the display – to increase or reduce the current output press “+” or “-”. The vertical bar graph at the bottom of the display indicates which of the six current output steps is being used. If the transmitter can supply the requested current, the bar will turn black. If the bar does not turn black, improving the ground connections or wetting the ground where the earth stake is positioned, may help. However, it may not be able to achieve the current setting requested because the impedance of the line is too high for this setting. If this happens it is best to select a lower setting that has a black bar, this will ensure a stable output.

The current being transmitted will be limited by the impedance of the target line, therefore it is not unusual to increase the output level, but see no increase in the current displayed. This is not a fault with the transmitter.

The transmitter will always revert to first level output when switched on – this is a power saving feature – in most circumstances this output level is sufficient. Increasing the output power unnecessarily will reduce the battery life unnecessarily. All other settings remain the same as the last setting used.

5.4.2 Most Used Frequencies Feature

This feature can be used to allow the operator to choose the most used frequencies from a list of possible frequencies. Once these frequencies are selected in the main menu, by pressing the “f” pushbutton, the user can scroll through them. At any time the user can add or remove frequencies from the above list, by following the below procedure. The maximum number of frequencies that can be activated in most used frequencies list is 12.

5 Loc3-10Tx Transmitter

The advantage of this feature is that user can work with only their preferred frequencies, instead of having a whole list of frequencies to scroll through.

To enter the "Frequency Menu" proceeds as follows:

1. Press the "i" pushbutton four to six times (based on the mode that transmitter is in) until reaching the "Frequency menu" sub-menu.

In Direct Connection mode,

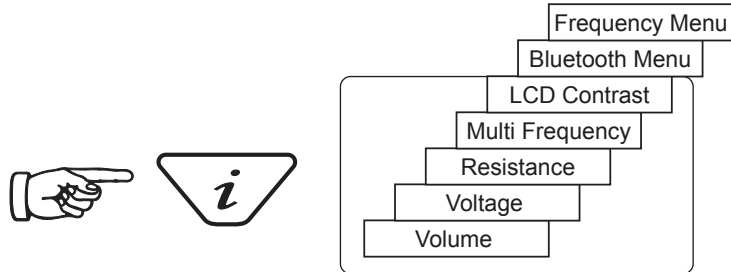

In SD mode,

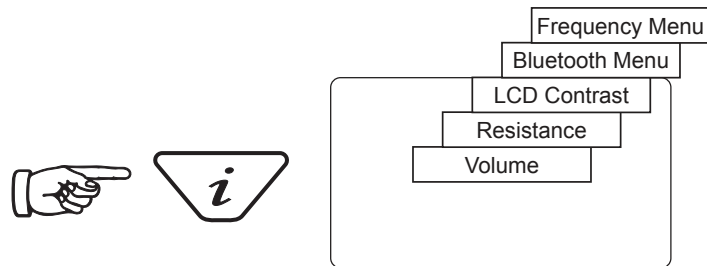

In Clamp mode,

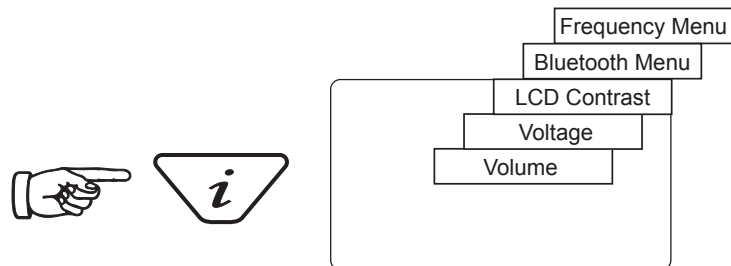

2. Screen will show a list of frequencies available, with the central one in a box.

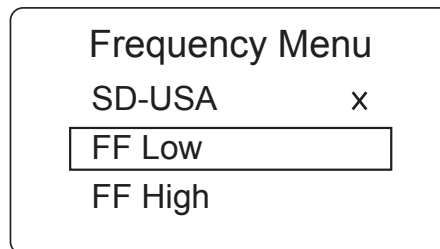

5 Loc3-10Tx Transmitter

- Pressing the “+” or “-” pushbuttons, you can scroll up or down through the available frequencies.
- Once the wanted frequency is inside the box, press “f” pushbutton to select or deselect the frequency. An “x” will appear in the box for a selected frequency.

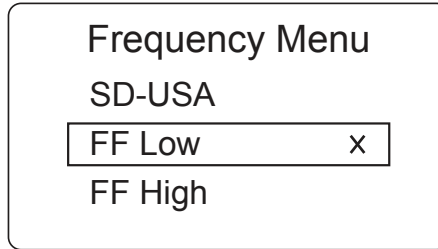

- After selecting the frequencies, press the “i” pushbutton again to exit the “Frequency Menu” and return to the main display.
- A particular frequency in the chosen list of frequencies can be selected from the main display screen by pressing the “f” pushbutton until the wanted frequency is displayed at the top of the main screen.

5.4.3 Multi-frequency Mode for Direct Connection

This feature can be used to energize two/three frequencies at the same time on the target line. This is especially helpful when user is not sure which frequency is best to apply to the target line. The multi-frequency mode is not available in Fault Find and SD modes.



NOTE

- When using the multi-frequency mode, total power will be split between the activated frequencies.
- The frequencies have to be available in the main menu.

To enter the “Multi-frequency Setup” menu:

- Press “i” pushbutton seven times to get to the “Multi Frequency” screen and press “f” pushbutton to activate the multi frequency mode. An “x” symbol will appear indicating that multi frequency mode is activated. Press “f” pushbutton again to go in “Multi Freq. Setup” screen to choose the frequencies.

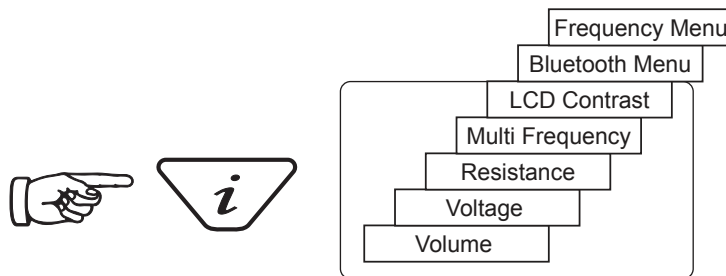

- Use the “+” and “-” pushbuttons to scroll through the available frequencies, and bring the wanted one in the first box.

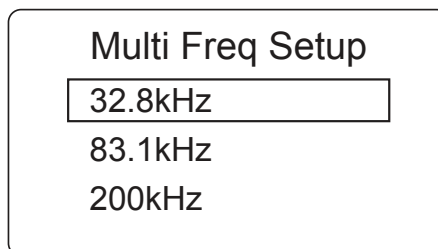

5 Loc3-10Tx Transmitter

3. Press "f" pushbutton to move the box down and the "+" and "-" pushbuttons to select the second frequency.

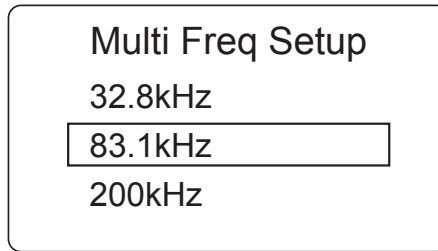

4. Repeat step three to select the third frequency if needed.
5. Press "i" pushbutton to return to main display. On the main display, "Multi" will appear indicating the multi frequency mode is active.

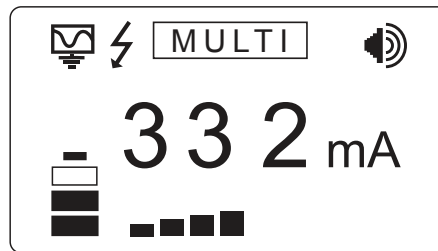

6. The frequencies selected for multi frequency mode will be saved until changes are made even when the multi-frequency mode is deactivated.

5.5 Remote the Operation of transmitter

The Loc3-10Tx can be remotely operated from the Receiver. This is an optional feature and requires the long range Bluetooth option to be installed in both the vLoc3 and Loc3-10Tx. This feature is only available on the Loc3-10Tx and is a factory fit option so must be requested at the time of ordering. The range of the radio link depends on having a clear "Line of sight" between Rx and Tx but is typically around 300m.

Linking a transmitter to a receiver:

Switch on the transmitter, press the information button repeatedly to scroll through the options until the "RECEIVER LINK DISABLED" option is displayed.



5 Loc3-10Tx Transmitter

Press the "+" key to enter the Receiver Link menu.

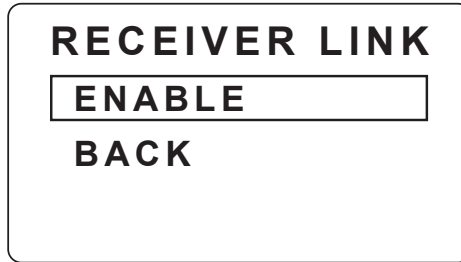

Press the "+" or "-" key to highlight the "ENABLE" option, then press the "F" key to start the process. The display will show the message "WAIT" until setup is complete.

An ID number-will now be displayed at the bottom of the screen for identification purposes.

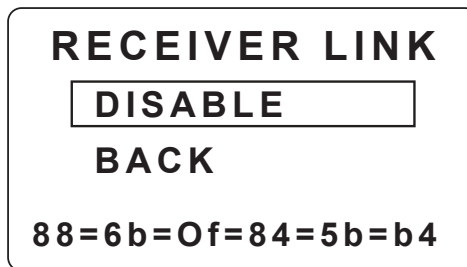

The transmitter is now waiting to connect to a receiver.

Either press the "I" button or use the "+" and "-" keys to highlight "BACK" then "F" key to exit back to the main screen.

When in the Main screen a "beacon" icon will be displayed on the right hand side. When the icon is flashing the transmitter is waiting to connect to a receiver. The flashing will stop when successfully connected to the receiver. If no icon is visible this indicates that the Receiver Radio Link has not been activated.

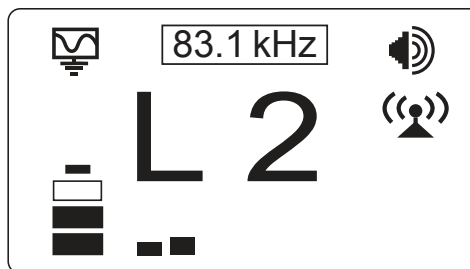

While the Icon on the transmitter is flashing, indicating that it is waiting to connect to a receiver, switch on the vLoc3-9800 receiver and enter the user menu by pressing and holding the information button. Scroll down the menu options until Transmitter Link is highlighted.

NOTE: The transmitter and receiver sides of the radio links can be switched on in any order.

5 Loc3-10Tx Transmitter



Select the “Transmitter Link”. Check that the radio module is enabled. If not, press the return button to enable the Transmitter Link.

After a short scan, the available devices will be displayed. Highlight the one to be selected and press the return button. Press the information button to return to the main menu.

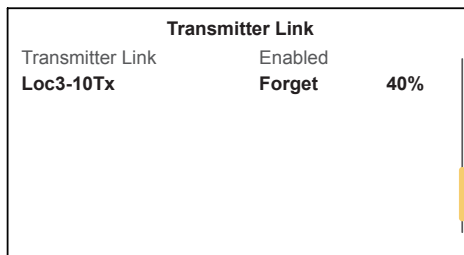

The “Beacon” icon on the transmitter should not be flashing anymore at this point. A solid icon indicates that the link has been established.

From the main menu select “Transmitter Control” option that will become visible when the two devices are linked.

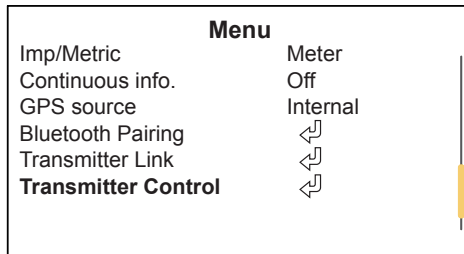

A screen similar to this should be seen

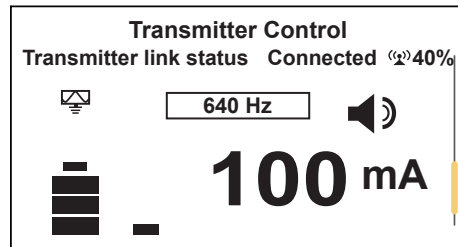

From this screen, if the link status shows “Connected”, it is possible to:

1. Alter the output level of the transmitter using the “+” and “-” buttons.
2. Alter the transmit frequency using the “f” button.

Also shown is the:

- Radio link signal strength, in this case 40%.
- Output mode, in this case direct connection.
- Output current, in this case 100mA.
- Beeper volume setting, in this case level 2.
- Transmitter battery level.

Use the Information button to navigate/Exit back to the locate screen.

When in the Locate screen the status of the Link is displayed in the Status bar.



The various indications of the status are listed below:

	No radio module or it is disabled (Always disable in the User Menu when not in use)
	No link and no signal
	No link and poor signal
	No link but good signal
	Is linked to the transmitter but signal is poor
	Is linked to the transmitter with a good signal

TIP



While the Transmitter and Receiver are linked, changing the Receiver Frequency will automatically result in a similar change to the Transmitter frequency, so there is no need to re-enter the menu screen to change the Transmitter frequency remotely. The Frequency indicator will flash when resetting or if an invalid frequency is requested.

If the Tx/Rx Radio link is not being used, make sure the receiver's link is set to "Disabled" on both RX and TX as the radio link will continue to search for the transmitter or receiver and may interfere with the Bluetooth operation. Also, disabling when not in use will conserve battery charge.

6. Loc3-5Tx Transmitter

6.1 Loc3-5Tx Transmitter Overview



6.1.1 Display

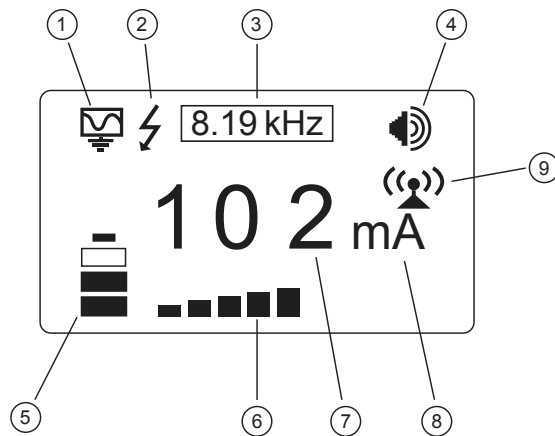

1	Mode Indication Icon	6	Output Setting (Step) (filled box indicates current level has been reached, empty box indicates requested current level has not been achieved)
2	High Voltage Warning* (output is enabled for high voltage)		
3	Frequency Being Transmitted	7	Digital Read Out (mA, volts, ohms)
4	Loudspeaker Level	8	Units (mA, volts, ohms)
5	Battery Status	9	Blinking icon = Tx-Link is not paired Solid icon = Tx-Link is active and linked to transmitter

***External Voltage Warning**

The transmitter checks the line when connected. If the line is carrying voltages in excess of 25V, it will display the “high voltage” warning icon, and not allow the transmitter to operate. In addition, the transmitter is protected in the event of excessive voltage or voltage spikes on the line.

6.1.2 Pushbuttons

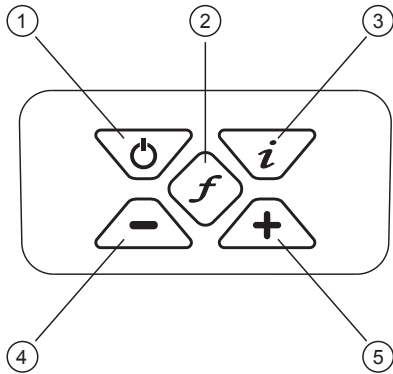

1	On/Off Control
2	Frequency Select
3	Information (Volume, Volts, Ohms, LCD Contrast, Multi Frequencies, Frequency Menu)
4	Output Decrease/Navigate through menu
5	Output Increase/Navigate through menu

6.1.3 Information Pushbutton

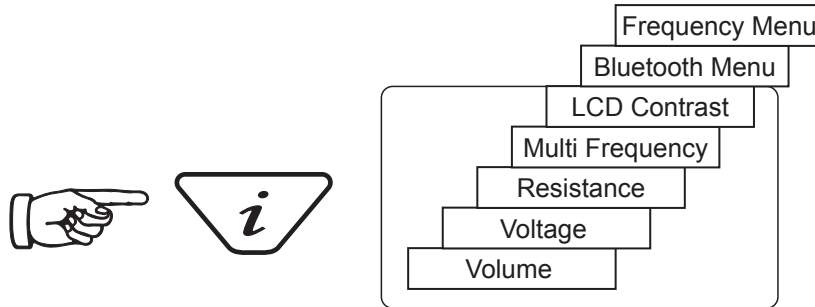

When the “i” (information) pushbutton is pressed, the display will show the audio volume level , use the “+” and “-” pushbuttons to increase/reduce the volume or turn the beeper off (off – low – medium – high).

By pressing the “i” (information) pushbutton the display can be toggled to show “voltage” and “resistance”. The display indicates mA, as the default, and volts or ohms when selected.

6.2 Transmitter Battery

 By default, transmitters are shipped with eight D cell alkaline batteries. A rechargeable Li-Ion (Lithium-Ion) battery kit is available as an accessory. The battery status is displayed on the left side of the display.

The letters “LP” will appear when the battery status reaches only one bar. At this battery level the max output current and power is limited.

6.2.1 Removing the Battery Tray

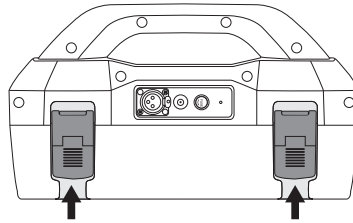

Pull out bottom of catch

6.2.2 Replacing the Alkaline Battery

- To access batteries – undo the two latches that are locking the battery cover.
- To remove batteries – remove the battery holder from the inside of the unit.
- Replace batteries with new batteries of the same type, be sure not to mix old and new batteries.
- **Do not** use rechargeable batteries in the alkaline battery tray. Ensure that batteries are inserted the correct way (see label and molded “-” and “+” in the bottom of the tray).
- Refit the battery tray – then close the battery cover.



WARNING

Alkaline Batteries – insert alkaline batteries (x 8) as shown:

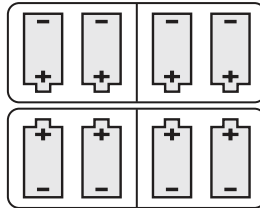

6.2.3 Rechargeable Batteries

- **Do not** attempt to replace the rechargeable batteries or remove battery covers – return to Vivax-Metrotech or a Vivax-Metrotech approved service centers for replacement.



WARNING

Use only Vivax-Metrotech recommended charger.

6.2.4 Re-fitting the Battery Tray

To close the battery tray – slide the transmitter (TX) onto tray, it will locate itself in the correct position, then close the catches.

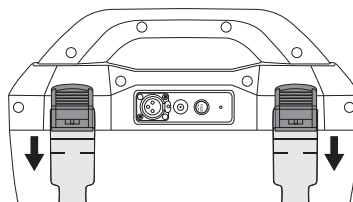

Push up button underneath the catch – where holding that up push in the bottom of the catch. You will hear a positive “click”.

6.2.5 Rechargeable Battery Pack Charging and Disposal

Follow the instructions in the General Safety & Care section portion of this document.

Only use the battery charger supplied with the battery. Using a non-approved charger may damage the battery pack and could cause overheating.

The rechargeable battery pack must be connected to the transmitter in order to charge. Connect the charger to the charging socket on the inside of the transmitter and connect the charger to a suitable mains socket.

The LED on the charger will show a red light indicating that the charge cycle is in progress. When the batteries are fully charged the LED will change to green.



NOTE

Rechargeable pack cannot be charged from a 12V DC source.

6.3 Transmitting Modes

The transmitter has three transmitting modes, which are selected automatically.

6.3.1 Induction Mode

This uses an internal antenna to induce a locating frequency onto the target pipe or cable (line). “Induction” mode is automatically selected if no connection accessories are plugged into the “output socket”. An icon indicating “Induction” mode shows on the display. The icon flashes when the transmitter is transmitting. In order to generate successful induction, the transmitter should be positioned over and with the handle perpendicular to the target line.

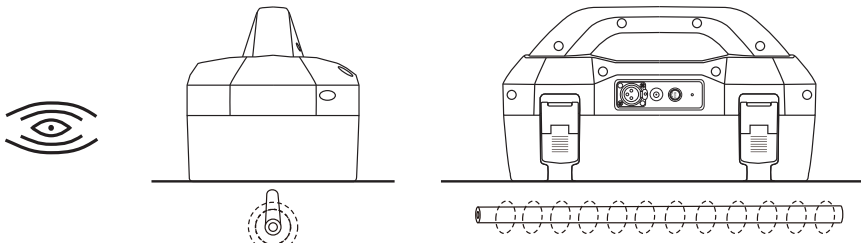

“Induction” mode is generally used when no access is available to make a direct connection, or a clamp connection. When using induction it is very likely that the signal being induced onto the target line will also be induced onto other lines in the area, and onto above ground features such as wire fences. This can influence the accuracy of the location, depth and current measurements. “Induction” mode is also the least efficient way of applying the transmitting signal to the target line. The distance located with “Induction” mode is generally much less than that achieved with a direct connection or clamp connection.

“Induction” mode generally works better in higher frequencies. The advantage of induction is that no access is required to “connect” the transmitter, making it a very quick process. The antennas on the transmitter are tuned to induce specific frequencies or range of frequencies. Therefore only a limited number of frequencies can be selected in “Induction” mode.

All the frequencies in favorite frequencies mode that are higher than 8 kHz can be selected by pressing “f” pushbutton in main display. Multiple induction frequencies are available based on the user selection. See section 1.4.2 for adding and removing frequency from the favorite frequencies list.



NOTE

For accurate location and depth measurement the locator receiver should be used no closer than 50ft (15m) from the transmitter.

6.3.2 Direct Connection Mode

By plugging in a connection lead to the output socket, “Direct connection” mode is selected. An icon confirming this is shown on the display. The wave in the icon fluctuate when the transmitter is transmitting. The direct connection lead consists of two cables, one (red clip) must be connected to the conductor being located, the other (black clip) to a suitable ground (a ground stake is provided with the transmitter). An auxiliary ground lead is also supplied. If the auxiliary ground lead is used, the ground clip of the connection lead (black clip) is attached to one end of the auxiliary ground lead.

A good connection is indicated by a change in beep rate from the speaker and the current reading on the display.

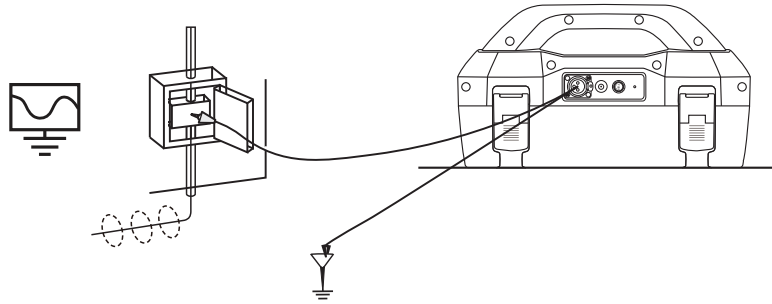

Wherever a direct connection can be safely made without the risk of injury, damage to customer’s plant, or the transmitter, it is the best way of applying the transmitter’s signal.

The coupling of the transmitted signal to other pipes and cables in the area will be much less than with induction, although where commonly bonded systems are encountered – coupling cannot be avoided.

The positioning of the ground connection can also influence the degree of coupling experienced. Ground connections generally should not be made to other pipes or cables, or above ground metallic structures such as wire fences. In general the lower the frequency is, the further the signal will travel, and the less signal coupling will occur. The most common frequencies used for direct connection are between 512 Hz/640 Hz and 8 kHz.

Regulations in many countries require that power output is limited above certain frequencies. The Loc3-5Tx enables frequencies below 45 kHz to be transmitted using as much as 5 watts output, but frequencies over 45 kHz are restricted to 1 watt. Using direct connection and the higher power at the low frequencies helps significantly in achieving greater location distances. Direct connections should not be made to cables carrying greater than 25V (or as your safety practices allow). The transmitter is protected (250V fuse) from stray currents that may exist on the target line.

6.3.3 Clamp Mode

Plugging the signal clamp supplied by Vivax-Metrotech into the output socket will place the transmitter in “Clamp” mode. An icon confirming this is displayed on the display. The icon flashes when the transmitter is transmitting. When using the clamp no ground connection is needed.

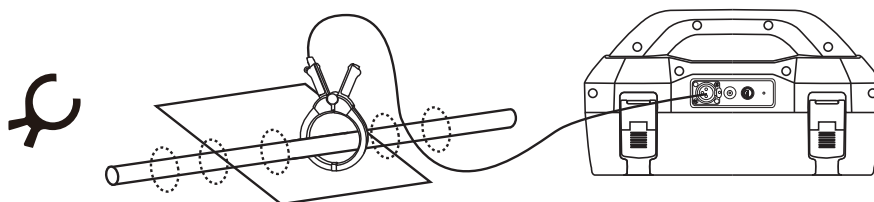

The clamp again is a precise way to apply the locating signal. It is generally used when access to the conductor cannot be achieved to make a direct connection (but there is sufficient access to place the clamp around the cable), or when it is not safe to make a direct connection because the target cable is carrying electricity.

The clamp is a specialized inductive device (sometimes known as a toroid or coupler). All clamps are optimized to work at specific frequencies. In most cases clamps are designed to be used at frequencies generally between 8 kHz and 200 kHz. The transmitter will only allow the selection of a suitable range of frequencies for your clamp.



WARNING

When applying the clamp to cables that carry electricity – be sure to follow your company’s safety instructions and procedures. Beware that if applied around a high voltage cable – that cable may induce a current in the clamp causing it to snap shut or jump quite dramatically – always apply clamps carefully.

6.4 Frequencies

6.4.1 Frequencies and Power Output

The Loc3-5Tx transmitter is supplied with a predefined set of transmit frequencies. The most commonly used frequencies are preset by the factory. Additional frequencies can be added from the frequency select list. (See section 1.4.2 for access to this menu).

Example of standard frequencies/preset at the factory are:

- 512Hz (where electrical systems are 60Hz) direct connection – 5 watts.
- 640Hz (where electrical systems are 50Hz) direct connection – 5 watts.
- 8 kHz direct connection – 5 watt.
- 33 kHz direct connection – 5watt.
- 65 kHz direct connection – 1 watt.
- 83.1 kHz, 131 kHz direct connection – 1 watt (depending on region).
- 200 kHz direct connection – 1 watt (depending on region).
- Some other frequencies with 5Watt output:
 - o Direction connection: 256Hz, 491Hz, 982Hz, etc.
 - o Direct and clamp connection: 8.19 kHz, 8.44 kHz, 9.5 kHz, 9.82 kHz, 32.8 kHz, 38 kHz.
- Some other frequencies with 1W output: 89 kHz, 131 kHz, 200 kHz.
- Clamp connection: any frequency from 8 kHz up to the highest allowed frequency (depending on region).
- Induction Frequency: this transmitter is a broad-band induction unit. It means that user can select for the induction mode any frequency he wants, from 8 kHz up. (highest available frequency depends on region) NOTE: see section 1.4.2 for frequency activation procedure.

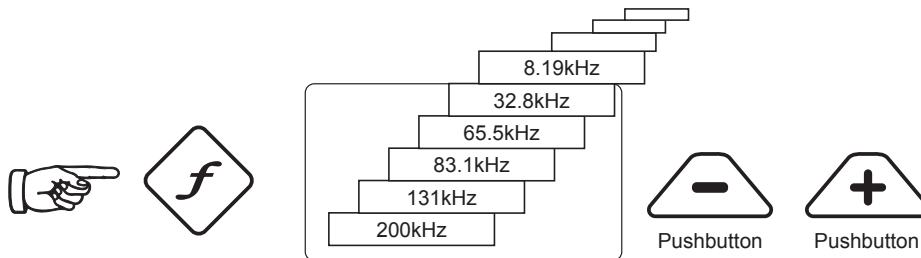

As with most manufacturers the clamps and induction antennas are tuned to specific frequencies, and do not work over the complete range of frequencies.

Frequencies are selected by pressing the “f” pushbutton which toggles through the available frequencies for the selection mode. The frequency is automatically selected if you don’t toggle past it within two seconds. The frequency is shown on the display.

NOTE:

The output current is shown in large characters on the display – to increase or reduce the power output press “+” or “-”. The vertical bar graph at the bottom of the display indicates which of the five current output steps is being used. If the transmitter can supply the requested current, the bar will turn black. If the bar does not turn black, improving the ground connections or wetting the ground where the earth stake is positioned, may help. However, it may not be able to achieve the current setting requested because the impedance of the line is too high for this setting. If this happens it is best to select a setting that has a black bar, this will ensure a stable output.

The current being transmitted will be limited by the impedance of the cable, therefore it is not unusual to increase the output level, but see no increase in the current displayed. This is not a fault with the transmitter.

The transmitter will always revert to first level output when switched on – this is a power saving feature – in most circumstances this output level is sufficient. Increasing the output power unnecessarily will reduce the battery life unnecessarily. All other settings remain the same as the last setting used.

6.4.2 Most Used Frequencies (Frequency Selection) Feature

This feature can be used to allow operator to choose his most used frequencies from a list of possible frequencies. Once these frequencies are selected in the main menu, pressing the “f” pushbutton, user can scroll through them. At any time user can add or remove frequencies from the above list, following the below procedure. Maximum frequencies that can be appear in most used frequencies list is 12.

The advantage of this feature is that user can optimize the transmitter and activate at the main menu user’s preferred frequencies, instead of having a whole list of frequencies that user has to scroll through.

To enter the "Frequency Menu" proceeds as follows:

1. Press the “i” pushbutton four--six times (based on the mode that transmitter is in), until get to the "Frequency menu" sub-menu.

In Direct Connection mode,

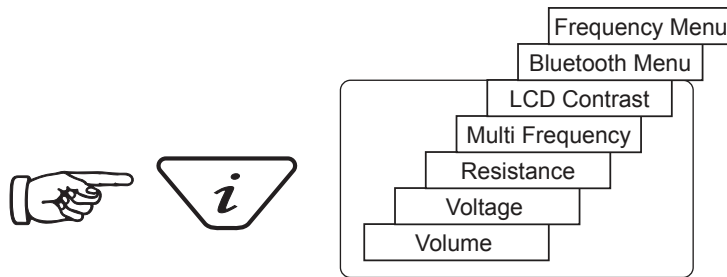

In SD mode,

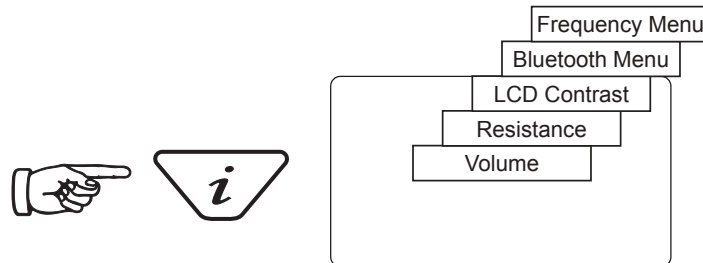

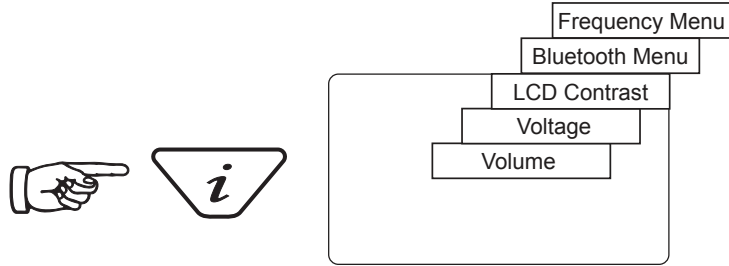

6 Loc3-5Tx Transmitter

In Clamp mode,

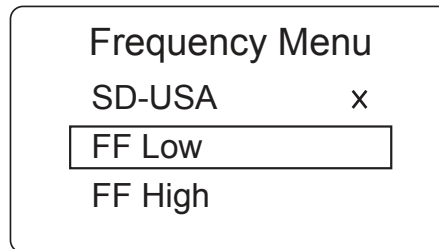

2. Screen will show a list of frequencies available, with the central one in a box.



3. Pressing the "" or "" pushbuttons, you can scroll up or down through the available frequencies.
4. Once the wanted frequency is inside the box, press "f" pushbutton to select or deselect the frequency. An "x" will appear in the box for a selected frequency.

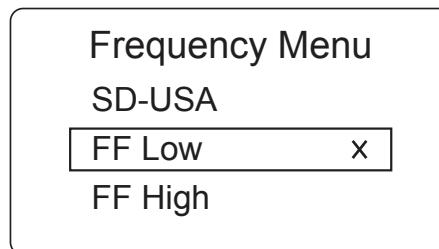

5. After selecting the frequencies, press the "i" pushbutton again to exit the "Frequency Menu" and return to the main display.
6. A particular frequency in the chosen list of frequencies can be selected from the main display screen by pressing the "f" pushbutton until the wanted frequency is displayed at the top of the main screen.

6.4.3 Multi-frequency Mode for Direct Connection

This feature can be used when user wants to energize on target two/three frequencies at the same time. Mainly, it can be used when user is not sure which frequency can be impressed better into the target. Multi frequency mode is not available in Fault Find and SD modes.



NOTE

- When using multi frequency mode, total power will be split between the activated frequencies.
- The frequencies have to be available in the main menu.

To enter the "Multi Freq. Setup" menu, proceeds as follows:

1. Press "i" pushbutton four times to get to the "Multi Frequency" screen and press "f" pushbutton to activate the multi frequency mode. An "x" symbol will appear indicate the multi frequency mode is activated. Press "f" pushbutton again to go in "Multi Freq. Setup" screen to choose the frequencies.

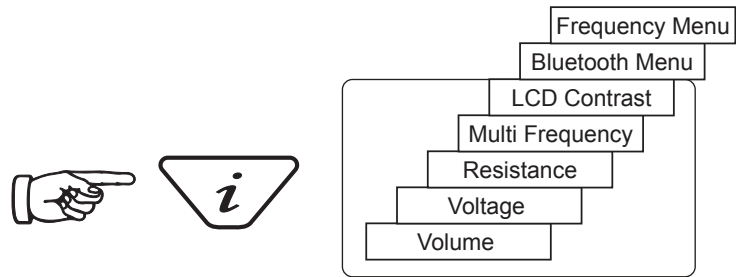

- Pressing the " \triangleleft " and " \triangleleft " pushbuttons to scroll through the available frequencies and bring the wanted one in the first box.

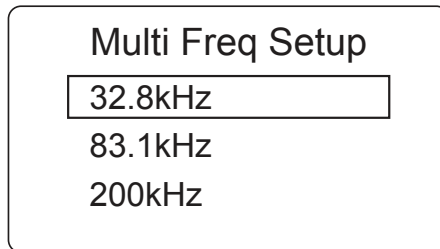

- Press "f" pushbutton to move the box down and the " \triangleleft " and " \triangleleft " pushbuttons to select the second frequency.

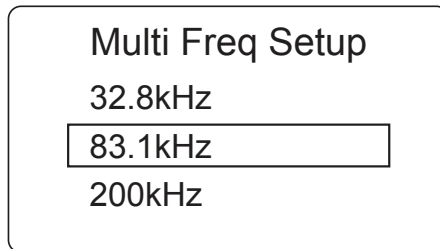

- Repeat step three to select the third frequency if needed.
- Press "f" pushbutton to return to main display. On the main display, "Multi" will appear indicating the multi frequency mode is active.

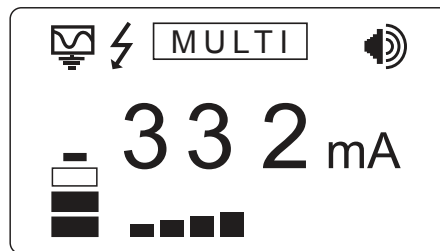

- The frequencies selected for multi frequency mode will be saved until changes are made even when the multi frequency mode is deactivated.

6.5 Transmitter Battery

6.5.1 Replacing Alkaline Batteries

- Replace with new batteries of the same type, be sure not to mix old and new batteries.
- **Do not** use rechargeable batteries in the alkaline battery tray. Ensure that batteries are inserted the correct way (see label "−" and "+") on the side of the tray).
- Refit the battery tray, place it inside the housing and close the battery cover.



WARNING
Alkaline Batteries – insert alkaline batteries (x8) as shown.

6.5.2 Rechargeable Batteries

- Do not attempt to replace the rechargeable batteries or remove battery covers – return to Vivax-Metrotech or a Vivax-Metrotech approved service centers for replacement.



WARNING
Use only Vivax-Metrotech recommended charger.



WARNING
Charging socket.



The one pin plug is used for power in from charger (to charge rechargeable batteries).



NOTE
Rechargeable pack cannot be charged from a 12V DC source.

Contact Vivax-Metrotech or a Vivax-Metrotech approved service center for wiring diagram of plug, if attempting to repair any of the "charging" leads.

6.5.3 Battery Charging and Disposal

Follow instructions detailed in the General Safety & Care portion of this document.

Only use the charger supplied with the equipment. Using a non-approved battery charger may damage the batteries and cause overheating.

The charger is mains operated. Connect the charger to the battery pack at the rear of the transmitter. The LED on the charger will show a red light indicating that the charge process has started. When the LED changes to a green indicator the charge sequence is complete and the batteries will be fully charged.

7. Using the vLoc3-9800

7.1 Using the Accessories

7.1.1 Using the LPC Separation Filter



The LPC separation filter (LPC) is used to safely inject a trace tone to a live cable via a domestic mains socket, so that the cable can be traced from the premises to the connection in the street. It is suitable for connecting to voltages up to 250V AC.

Method:

- Plug the LPC into the output socket of the transmitter.
- Identify a suitable main socket. If a switch is fitted to the socket, switch off. Plug in the LPC to the mains socket and then switch back on.
- Set the LPC rotary switch to match the two indicator lights.
- Set the transmitter to the frequency to be located.(8 kHz or 32 kHz are good frequencies for this application).
- Set the output to mid-range.

7.1.2 Using the Analogue A-frame Fault Finding Accessory



The analogue A-frame accessory is used to detect ground faults on pipes and cables. In the case of pipes, the faults consist of coating defects. In the case of cables, faults are usually caused by insulation damage allowing the metallic sheath (or internal conductor) to become in contact with the ground.

It is intended to be used with the vLoc3 range of locators and will require a fault find signal applied to the faulty conductor from a Vivax-Metrotech compatible transmitter.

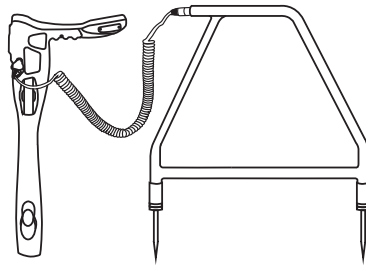

Fault finding requires a non-standard signal “8kHz FF”

To detect a damaged section, the line should be isolated and have all ground bonding removed. This will ensure that the ground fault is not masked by deliberate bonding to ground. The A-frame cannot distinguish between these two situations.

After isolating the line, use the transmitter resistance measuring function, or a dedicated resistance measuring device to confirm that there is a fault to ground. The A-frame will typically detect faults up to 2 Mohm (depending on the distance from transmitter, soil conditions etc).

A ground stake needs to be pushed into the ground and the black cable clipped to it. Try to place the ground stake as far as possible from the line to be evaluated. This ensures return currents do not distort the results.

Always connect the ground stake first when connecting up and last when disconnecting. Make the connections before switching on as hazardous voltages can be present on the connection clips.

Connect the transmitter to the target line using the red lead. Switch on the transmitter and select either 8kFF low or 8kFF high. Use 8kFF high if the line to be surveyed is long or the fault resistance is high. Make sure the receiver and transmitter are set for the same FF type, ie 8kFF.

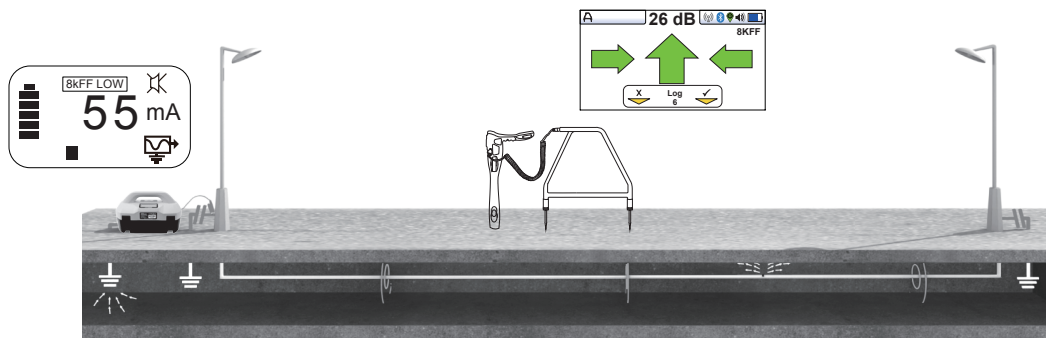

Plug in the A-frame to the receiver accessory socket. When the receiver is switched on, it will automatically default to the A-frame screen.

Note also the Auto shutdown setting will be set to “Never shutdown” when the A frame is attached.

7 Using the vLoc3-9800

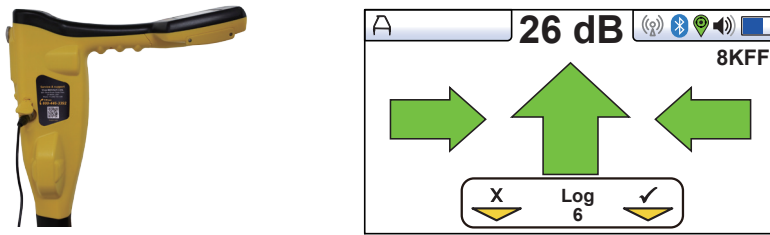
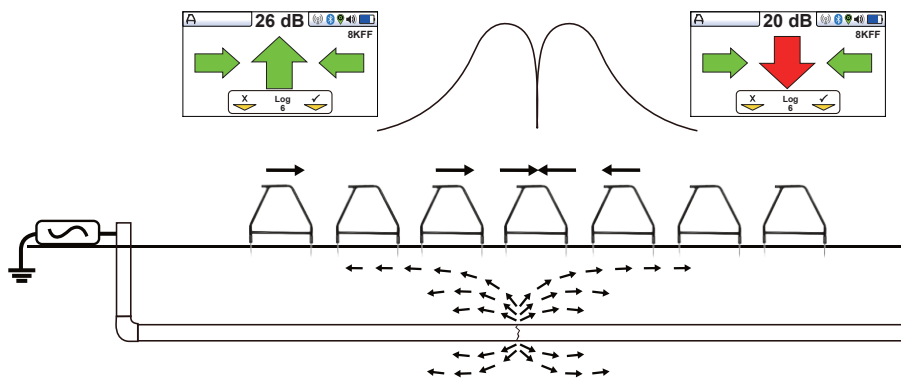

Image for reference only and may differ from actual image

Remove the plastic spike covers from the A-frame. Walk along the route of the line placing the spikes of the A-frame in the ground (with the green leg pointing away from the transmitter connection point) every two or three paces.

If starting near the transmitter, the arrow on the display will point away from the ground point. As the distance from the transmitter increases, the dB reading will reduce and eventually the arrow will fluctuate or disappear altogether. This is because the fault location is further along the line. Use the left/right arrows to ensure the A-frame is positioned over the line and continue placing the A-frame in the ground every two or three paces. If necessary, use long presses of the “M” pushbutton to enter the locate screen allowing the user to confirm the position of the target line. Use long presses of the “M” pushbutton to scroll through the screens to re-enter the A-frame mode.



(Note that the A-frame is not shown connected to the receiver so as to simplify the diagram)

Eventually, the A-frame will detect the fault signal and the “Fault Find” arrow will point forwards. Continue moving forwards, it may be worth reducing the distance between measurements points as the fault is neared. The dB reading will increase as the fault is neared. Maximum reading will be just before and just after the fault. When over the fault, the dB reading will drop and the arrow will flip backwards indicating that the position of the fault has been passed.

Carefully place the A-frame before and after the fault to pinpoint the position. Repeating this across the line direction will pinpoint the fault laterally. The fault will be at the point where the lateral fault is identified.

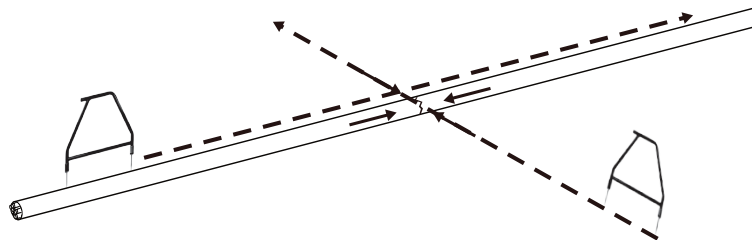



WARNING

Always disconnect or isolate target/faulty/suspected cables before connecting the transmitter to it. Never attach the transmitter to live cables.



TIP

If it is suspected that there is just one fault, insert the A-frame approximately one meter from the earth stake. Note the dB reading - this is approximately the maximum dB reading that will be measured over the fault.

A-frame Datalogging.

Data logging is possible when the A-frame is connected. Make sure the A-frame is located in the desired position with the pins firmly inserted in the ground.

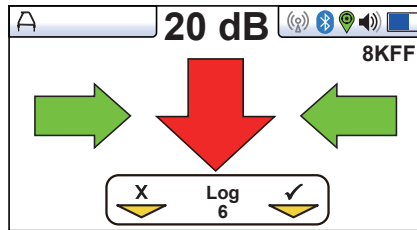

To record data press the "+" button. The soft key on the display will momentarily go green indicating that the data is stored, and the Log number will increment.

The data log can also be deleted from the Info screen. From the A-frame screen press and hold the "-" key. The message below will be shown.

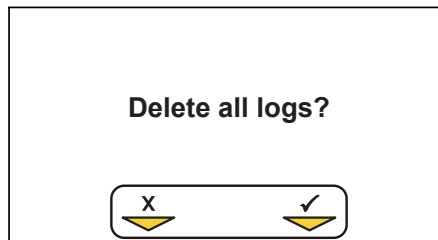

Press the "+" key to confirm. The locator will ask again "Are you sure?". Press the "-" key to delete or the "+" key to cancel the deletion and return to the locate/accessory screen.

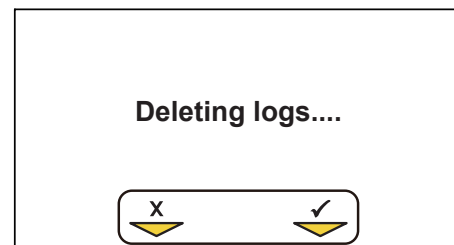
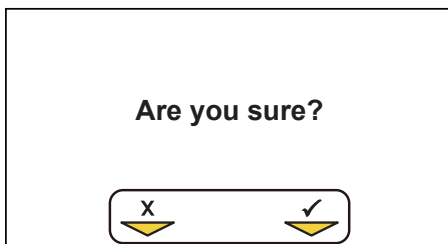

7.1.3 Using the vLoc3 Remote Antenna



The remote stethoscope antenna can be used to help trace a particular cable on a cable tray or where cables are bunched together.

Methods:

1. Connect a signal to the cable to be identified. The remote stethoscope functions has an operational frequency range of 512Hz up to 200 kHz, but low frequencies should be a preference in this application as they are less likely to leak or bleed over to other cables.
2. The best method of signal application when identifying cables is to use the signal clamp. This is because the signal clamp applies a signal to the target cable and shares an equal amount with other cross bonded cables.

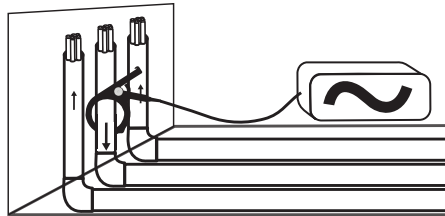

3. When using the signal clamp, it is best if both ends of the target cable are grounded. Applying the clamp below the ground point. Applying the clamp above the ground point will prevent the signal finding the return path through the ground, so this is not advised.

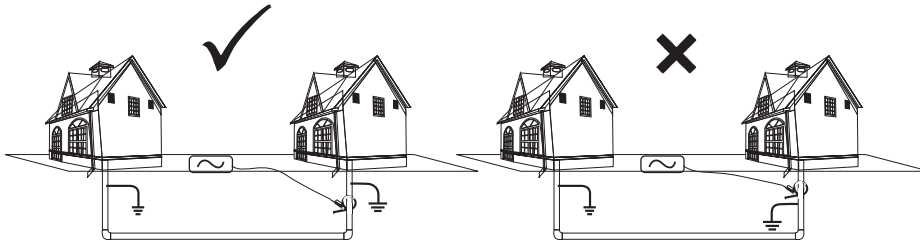

4. If it is not possible to use a transmitter signal clamp, and you have confirmation that the cable is out of service, use a direct connection lead to make an electrical connection to the cable. Removing any cross bonding between cables prevents the signal travelling along commonly bonded cables.

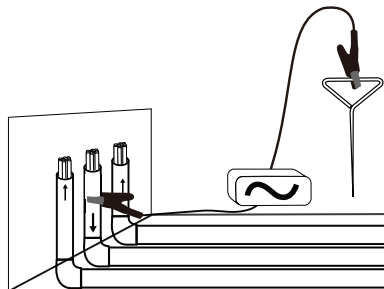

7 Using the vLoc3-9800

5. It is best **NOT** to use Induction method as the signal will appear on all cables in the area of the transmitter.
6. Connect the remote stethoscope antenna to the accessory input of the receiver. The correct settings and user interface will be automatically selected.

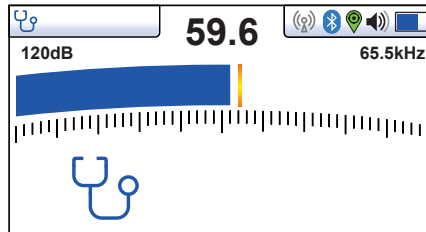

7. Ensure the frequency selected on the vLoc is the same as selected on the transmitter.
8. Place the stethoscope on each of the suspected target cables with the flats of the antenna in line with the route of the cable.

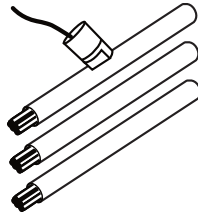

9. Note the signal reading of each cable. The one with the largest reading is likely to be the target cable.
10. If necessary, adjust the sensitivity of the vLoc3-9800 so that the signal is within the operating section of the bar graph.

Data logging is possible when the remote antenna is connected. To record data, press the “i” button, then press the “+” button as instructed on the screen



WARNING

The remote stethoscope antenna is a useful tool to help trace cables. However, it should not be used as positive identification before an unused cable is cut. Always follow company procedures when cutting disused or isolated cables.



TIP

The remote stethoscope antenna can be used to help trace disused and isolated cables. This process can be further enhanced if the cable is isolated and is of a twisted cable construction.

Method:

1. Connect the transmitter to two of the cores of the cable. At the far end, short together these two conductors making a loop.
2. Set the transmitter to a low frequency such as 640Hz and set the output to maximum.

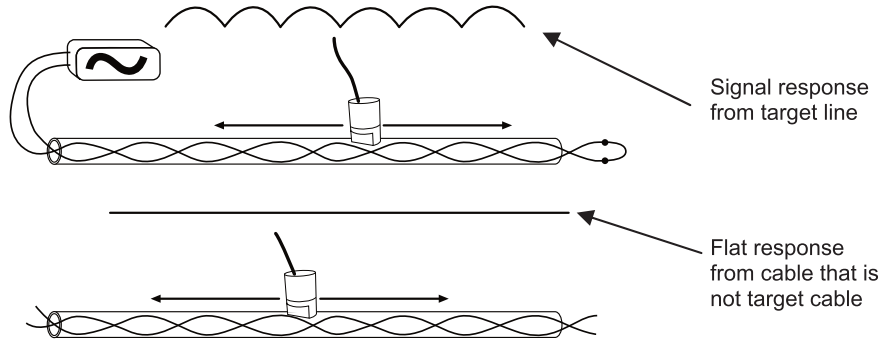

3. At the point of interest, if possible, part the suspected cable from the bunch then run the remote stethoscope antenna along the suspected target cable keeping the flat portions of the antenna in line with the cable. If the correct cable is being assessed the signal will increase and decrease in sympathy with the twist of the two conductors within the cable.
4. If the signal is a steady level and does not rise and fall, this is probably not the target cable.



WARNING

The remote stethoscope antenna is a useful tool to help trace cables. However, it should not be used as positive identification before an unused cable is cut. Always follow company procedures when cutting disused or isolated cables.

8. Accessories & Options

8.1 A-frame

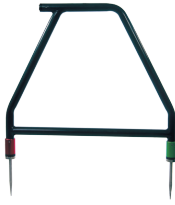

The A-frame accessory is used to detect ground faults on pipes and cables. In the case of pipes, the faults consist of coating defects. In the case of cables, faults are usually caused by insulation damage allowing the metallic sheath (or internal conductor) to become in contact with the ground.

8.2 Remote Antenna



The remote antenna can be used to help identify a particular cable on a cable tray or where cables are bunched together.

8.3 Loc3-10Tx Vehicle Power Lead

12V DC, 30ft (10m) lead to power the transmitter from a vehicle.



If it is intended to apply the transmitter to a target line at high output levels and long periods, it may be useful to power the transmitter using the 12V DC vehicle power lead. To power the transmitter from the 12V DC vehicle power lead, connect the lead to the 12V DC input positioned on the side of the transmitter. Plug the cigarette lighter plug into the vehicle cigarette lighter socket (be sure that the socket is live. Some vehicles only activate the cigarette lighter when the vehicle is running).

It is not necessary to disconnect or remove the standard batteries as the unit will automatically select the external 12V DC supply.

8.4 Loc3-10Tx Outdoor Power Supply



23V DC, 30ft (10m) lead to power and charge the transmitter from the mains supply.

8.5 LPC Separation Filter



The LPC separation filter (LPC) is used to safely inject a trace tone to a live cable via a domestic mains socket, so that the cable can be traced from the premises to the connection in the street. It is suitable for connecting to voltages between 100V AC and 250V AC.

8.6 Receiver Vehicle Charging Lead



12ft (4m) long lead to charge the receiver's battery (Lithium-ion) while on the move.

It is preferable to connect the charger to a cigarette lighter socket that is permanently live. However, **do not** leave connected to the receiver for excessively long periods

8.7 Sondes



D38-33-AA Sonde

- 1.5in (38mm) x 4.1in (105mm) long, 9.8 kHz, range 16.3ft (5m).
- 1 x AA battery.



D38-83-AA Sonde

- 1.5in (38mm) x 4.1in (105mm) long, 83 kHz, range 16.3ft (5m).
- 1 x AA battery.



D64-09-LR61 Sonde

- 2.5in (64mm) x 7.3in (186mm) long, 9.8 kHz, range 26ft (8m).
- 1 x LR61 battery.



D64-83-LR61 Sonde

- 2.5in (64mm) x 7.3in (186mm) long, 83 kHz, range 26ft (8m).
- 1 x LR61 battery.

8.8 Clamps



An accessory used to apply the transmitter signal to an insulated line, removing the need to connect the transmitter signal directly to a conductor or cable sheath.

- Available in 2-inch (50mm), 4-inch (100mm) and 5-inch sizes,
- An 18-inch (45cm) flexible version is also available

8.9 Clamp Extension Rod

Male thread for screwing into a clamp

Yellow handle (removable) /female thread for connecting to another extension rod



8 Accessories & Options

The extension rod is fitted with a 10mm screw thread. This male thread will screw into the handle of the signal clamp and will enable the clamp to be attached too hard to reach cables such as in manholes or overhead cables.

The extension rod is also fitted with a female thread in the handle which enables the rods to be fitted together to further extend the range. To access this thread the yellow handgrip needs to be slid off the end of the rod.

To operate the clamp jaws when attached to the rod, gently pull on the clamp cord which will open the jaws. Release cable to close them.

8.10 Ground Extension Spool



Used to extend the ground connection to a suitable grounding position.

8.11 Banana Plug Adapter

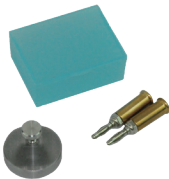

Adapts the direct connection crocodile clip to banana plug allowing the direct connection leads to be connected to a banana socket.

8.12 Loc3-5Tx and Loc3-10Tx Charger/PS



Mains charger (100-250V AC input) used to charge Loc3-5Tx or Loc3-10Tx rechargeable battery packs. Supplied as standard with rechargeable battery option.

8.13 Loc3-5Tx and Loc3-10Tx Rechargeable Battery Tray





The Li-ion rechargeable battery pack consist of the battery and charger.

8.14 vLoc3-MLA



Add on plug-in adapter for the purpose of locating buried EMS markers.

9. Glossary

Active Locate	A locate where a transmitter is used to apply a signal to a buried pipe or cable, the position of which is then located by a receiver tuned to the same frequency.
Active Signal	A signal applied by the locator transmitter to a buried line. Typical this is a very precise frequency.
Attenuation	The reduction of an electromagnetic signal from a pipe or cable.
Clamp (or Coupler)	An accessory used to apply the transmitter signal to an insulated line, removing the need to connect the transmitter signal directly to a conductor or cable sheath.
Compass	Line direction indicator (although visually like a compass, this is the only relation to a compass.)
Coupling	The act of signals transferring to lines to which they were not originally applied. Coupling can be "direct" where the target line has an electrical connection to another line, or "induced" where the signal radiates from the target line to another line or lines.
Display	The information visually available on the dot matrix display.
Line	A generic term for any buried pipe or cable.
Null	A minimum response to a buried line. 
Passive Locate	A locate where the receiver searches for a wide range of signals that radiate from buried pipes or cables. These signals come from a variety of sources in the environment and couple to the buried (& overhead) lines. Typical examples 50 / 60Hz and LF/VLF radio.
Passive signals	A wide range of signals that radiate from buried pipes or cables. These signals come from a variety of sources in the environment and couple to the buried (& overhead) lines. Typical examples 50/60Hz and LF/VLF radio.
Peak	A maximum response to a buried line. 
Pinpoint	Using a receiver to identify the exact position of a buried line.
Response	The indication that the receiver gives which is caused by the signals it is receiving. This can be visual, audio or both. Typically, it is displayed on the locator's dot matrix display and audibly from a loudspeaker in the receiver housing.
Search (sweep)	This describes the act of looking for a buried line within a given area.
Sonde	A small transmitting coil which may be built into a product such as a sewer camera or packaged as a small self-contained battery powered transmitter. A receiver tuned to the same frequency can locate the position of the Sonde and hence whatever it is attached to or in. Frequently used for locating sewer cameras, and the non-metallic pipes.
Target Line	The buried pipe or cable to be located.
Trace	Using a locator to follow the path of a buried line.

Illustrations used in the preparation of this manual will inevitably show some resemblance to similar illustrations from other Manufacturers-some manufacturers have given permission for the use of their graphics (Vivax-Metrotech & Seba) is given credit for these use. This statement is intended to attribute such credit.

Disclaimer: Product and accessory specification and availability information is subject to change without prior notice.

