



vLoc3-DM (Defect Mapper)
User Handbook
(English Edition)
Version 1.1
P/N: 4.04.000171



General Safety & Care Information

Who Can Use This Equipment

- This equipment must only be used by people suitably trained in the use of pipe and cable locators.

Work-site Safety

- Use your company's or other applicable safety codes and rules when using this equipment.
- Unless having the required authorization, license and appropriate training – do not make connections to any pipe, cable or conductor.
- The equipment should not come in contact with corrosive or hazardous chemicals, gases or dust.
- **Do not** directly connect this equipment to cables or pipes with a potential difference to ground greater than 25V AC.

Equipment Safety

- **Do not** open the enclosures (housings) of either the transmitter or receiver.
- Place the ground stake firmly in the ground before connecting the cable from the transmitter.
- **Do not** hold any uninsulated portion of the connection leads & clips when the transmitter is switched on.

Batteries and Environmental Safety

Vivax-Metrotech products use four types of batteries:

- Alkaline batteries
- Ni-MH (Nickel-Metal Hydride) batteries – rechargeable
- Lithium-Ion batteries – rechargeable
- Lithium-Metal batteries – (small non-rechargeable button cells for "clock" applications)

1. Alkaline Batteries (Non-Rechargeable)

- When replacing the alkaline batteries – use only the size and type specified – **do not** mix battery types (rechargeable and alkaline).
- **Do not** mix partially discharged and fully charged cells in the same battery pack – **do not** mix old with new.
- **Never** attempt to charge alkaline batteries.

2. Nickel-Metal Hydride Batteries (Rechargeable)

- When using rechargeable batteries, use only the correct charging device supplied or specified by the manufacturer. The battery pack or charger will contain circuitry to manage the charging process. Other chargers (even if they have the same connector, polarity, voltage & current rating will not have the same control circuitry and can cause damage to the product, overheating, and in extreme cases, fire or harm to the individual.
- **Do not** assume that if the plug fits, it is the correct charger – a charger with the correct part number **must** be used – just because it is a Vivax-Metrotech charger and the plug fits **does not** mean it is the correct charger.
- Before using for the first time, charge rechargeable batteries for six hours. If the rechargeable batteries **do not** last as long as anticipated – discharge fully and then charge for six hours.
- Care should be taken when charging batteries – **Never** repeatedly recharge batteries (or turn the power off & on) without using the instrument. If used with an inverter in a vehicle, charge the product, unplug the charger, and **not** charge again until the rechargeable batteries have been used for at least ten minutes. Failure to do this could result in the overcharging of the battery, which will shorten the battery's life and could, in some circumstances, cause overheating or fire.
- If the product becomes hot during the charging process, **immediately** unplug the charger and use the rechargeable batteries for at least ten minutes before recharging. If this reoccurs the next time the unit is charged – return immediately to Vivax-Metrotech for repair.
- **Do not** charge batteries for prolonged periods without using the locator for at least ten minutes. Charging for prolonged periods could overcharge the battery, reduce battery life, damage the locator and fire in extreme circumstances.

3. Lithium-Ion Batteries (Rechargeable)

- Lithium-Ion Batteries – some products use Lithium-Ion batteries – the requirements for marking and transportation are still developing. Please contact Vivax-Metrotech before shipping products containing Lithium-Ion batteries or Lithium-Ion battery packs on their own for any "special instructions."

4. Lithium-Metal Batteries (Non-Rechargeable)

- Commonly known as "button cells," these are small – non-rechargeable batteries used to power internal "clocks" within some units (similar to computers). Generally, they have a life of three to five years.
- Under no circumstances should any attempt be made to charge these batteries.
- Dispose of according to your company's work practice/environmental standards, the prevailing laws, or recognized best practice. Always dispose of batteries responsibly.

5. General Rules regarding Disposal of Batteries

- **Never** disassemble a battery or battery pack.
- **Never** dispose of in a fire or water.
- Dispose of batteries following your company's work practice/environmental standards, the prevailing laws, or recognized best practice. Always dispose of batteries responsibly.

6. Transportation of Lithium-Ion and Lithium-Metal Batteries

- The Lithium-Ion and Lithium-Metal batteries used in Vivax-Metrotech products meet the required safety standards and include the designated protection circuitry.
- Recent regulation changes require that when batteries with Lithium-Ion and Lithium-Metal batteries are transported, the packaging **must** include specified warning labels.
- **Please contact Vivax-Metrotech Customer Service (USA 1-800-446-3392, International +1-408-734-1400 (USA Pacific Time Zone)) for more details.**
- Regulations have also changed regarding the shipping of spare battery packs (battery packs that are not inside a product). There are limitations on the package's weight, and the packaging must be marked with the appropriate warning labels.
- **Please contact Vivax-Metrotech Customer Service (USA 1-800-446-3392, International +1-408-734-1400 (USA Pacific Time Zone)) for more details.**
- Vivax-Metrotech vLoc Series 3 products using Lithium-Ion battery are classified as "not restricted." They can be shipped normally by road/rail/sea & air (passenger & freight aircraft) without restrictions.



IMPORTANT

Remember – Batteries contain dangerous chemicals – They can be affected by many things such as water ingress or heat – In some circumstances, they can explode. They also can cause electric shocks!

Care of Equipment

- Use equipment only as directed in this User Handbook.
- **Do not** immerse any part of this equipment in the water.
- Store in a dry place.
- Keep equipment in the case provided when not in use.
- If left for a prolonged period – remove alkaline batteries.
- Keep unit clean and free of dust and dirt.
- Protect against excessive heat.

Care when Interpreting the Information provided by the Locator

- Like all locators – this instrument is locating and providing depth and current readings based on electromagnetic signals that radiate from the buried cable or pipe. In most cases, these signals will enable the locator to pinpoint both position depth and current correctly.
- **Beware** – in some cases, other factors will distort electromagnetic fields radiating from cable or pipe is located, resulting in incorrect information.
- Always locate responsibly and use information learned during your training to interpret the information provided by the locator.
- **Do not** provide information regarding cable or pipe depth to anyone unless authorized to do so by your company.
- **Remember** that depth measurements are to the center of the electromagnetic field or pipe – In the case of pipes, this may be significantly deeper than the top of the pipe.

American & Canadian Safety Notices

USA

- This transmitter and receiver comply with the general conditions of operation, pursuant to part 15 of the FCC Rules.
 - o CFR 47 Part 2
 - o CFR 47 Part 15
- Changes or modifications not expressly approved by the manufacturer could void the user's authority to operate the products.

CANADA

- Equipment is for use by trained operators only and not for general household or consumer use.
- Operation is subject to the following two conditions: (1) this device may not cause interference, and (2) this device must accept any interference that may cause undesired operation of the device.

EUROPE

- Vivax-Metrotech confirms that the location system is compliant with the relevant provision of European directive 1999/5/EC.
 - o EN 55011
 - o EN 61000-4-2: A1 & A2
 - o EN 61000-4-3
 - o EN 61000-4-8: A1
 - o ETSI EN 300 330-2
 - o ETSI EN 301 489-1
 - o ETSI EN 301 489-3

Table of Content

- 1. Service & Support 1
 - 1.1 Serial Number and Software Revision Number..... 1
 - 1.2 Distributors and Service Centers Closest to You:..... 2
- 2. Introduction 3
 - 2.1 About this Manual..... 3
 - 2.2 Overview of vLoc3-DM System 3
 - 2.3 Planning a Survey 4
- 3. vLoc3-DM Receiver Functions and Operations 5
 - 3.1 vLoc3-DM Receiver Overview..... 5
 - 3.2 DM Low-Frequency Sensor Foot 6
 - 3.2.1 Removing the DM Low-frequency Sensor foot 6
 - 3.3 Charging the Receiver Batteries 6
 - 3.4 The vLoc3 Series Keypad 7
 - 3.5 The vLoc3 Series User Menu..... 9
 - 3.5.1 Setup - Receiver 9
 - 3.5.2 Setup - Operational 10
 - 3.5.3 Setup - Features 12
 - 3.5.4 Setup - Informational..... 13
 - 3.6 Self-Test 13
 - 3.7 Warnings and Alerts 14
 - 3.7.1 Warning and Alerts Descriptions 14
 - 3.7.2 DFT (Discrete Fourier Transform)..... 14
 - 3.8 vLoc3 Series Locate Modes and Screens..... 16
 - 3.8.1 The Classic Screen Status Bar 16
 - 3.8.2 vLoc3-DM Receiver Classic Screen..... 16
 - 3.9 Classic Locating Modes (Response)..... 17
 - 3.10 Alternative Locate Screens..... 19
 - 3.10.1 The Vector Screen..... 19
 - 3.10.2 The Transverse Plot Screen..... 20
 - 3.10.3 The Plan View Screen..... 21
- 4. Using the vLoc3-DM Receiver 23
 - 4.1 Passive Locating 23
 - 4.1.1 Detecting Power Signals 23
 - 4.1.2 Detecting Radio Signals..... 24
 - 4.2 Active Locating - Applying the Locate Signal using the Loc3, 25-Watt Transmitter..... 25
 - 4.2.1 Direct Connection..... 25
 - 4.2.2 Transmitter Signal Clamp (25-watt transmitter)..... 26
 - 4.3 Locating a Pipeline 27
 - 4.4 Pinpointing..... 28
 - 4.5 Taking Depth and Current Readings (Information Screen)..... 29
 - 4.6 Storing the Results 29
 - 4.7 Clearing the log 30
 - 4.8 Graphing results on the screen 30
 - 4.9 The Walk-back feature 31
 - 4.10 Signal Direction Precision Identification..... 32
 - 4.11 Using the A-frame Fault Finder 34
 - 4.11.1 Fault Finding Method..... 35



4.11.2	Using the A-frame where there are Many Defects Such as Porous Coating.....	36
5.	Loc3 25-Watt Transmitter Functions and Operation	38
5.1	The Loc3, 25-Watt Transmitter Overview	38
5.2	Display.....	38
5.3	Pushbuttons	39
5.4	The Transmitter Connection Block	39
5.5	Transmitter Batteries	40
5.6	Charging the Transmitter Battery Tray	40
5.7	Removing and Installing the Battery Tray.....	41
5.8	Transmitter Modes.....	42
5.8.1	Direct Connection Mode.....	42
5.8.2	Clamp Mode.....	43
5.8.3	Transmitter Frequencies	43
5.8.4	Frequencies and Maximum Power Output.....	43
5.8.5	Most Used Frequencies (Frequency Selection) Feature.....	44
5.8.6	Multi-Frequency Mode for Direct Connection.....	45
6.	Loc-150Tx (150-Watt) Transmitter Functions and Operations	46
6.1	Transmitter Overview	46
6.2	Display.....	47
6.3	Power Supplies and Connections	47
6.4	Connecting to a Pipeline	47
6.4.1	Connecting at a CP (Cathodic Protection) Station	47
6.4.2	Connecting to the Pipe when there is No Access to a CP Station	49
6.5	Selecting the Correct Frequency.....	49
6.6	Output Current Select.....	50
6.7	Alarms	50
6.7.1	Over Voltage	50
6.7.2	Over Temperature	50
6.7.3	Overpower.....	50
7.	Using External GPS	51
7.1	Compatible GPS and GPS Data Loggers	51
7.2	Bluetooth	51
7.2.1	Fitting the Bluetooth Module	51
7.3	Pairing with external GPS/Dataloggers	51
8.	Transferring Data from the Locator	53
8.1	MyLocator3 Overview.....	53
8.2	MyLocator3's Basic Operation.....	53
8.2.1	Updates Page	53
8.2.2	Application Update	54
8.2.3	Locator Firmware update	55
8.2.4	Toolbar.....	55
8.2.5	Data Logging.....	55
8.2.6	Splash Screen.....	56
8.2.7	Frequencies Page.....	57
8.2.8	Menu Settings	58
8.3	Advanced Features	58
8.3.1	Supervisor Lockouts.....	58
9.	Interpreting Results.....	59
9.1	Introduction.....	59
9.2	Sources of Error	59
9.2.1	Operator Error.....	59
9.2.2	Interference (Distorted Fields).....	59

9.2.2.1	Source of Interference (Distorted Fields)	59
9.2.2.2	Checking for Distorted Fields	60
9.3	Viewing Data	61
9.3.1	Viewing .xls Files	61
9.3.2	Viewing .kml Files	62
9.4	Interpreting Graphs	63
10.	Care and Maintenance	64
10.1	Cleaning	64
10.2	Checking Functionality	64
11.	Glossary	65

1. Service & Support

1.1 Serial Number and Software Revision Number

Always quote your receiver or transmitter model, serial number and software revision number when requesting product support. They can be found as follows:



1	Model & Serial Number
---	-----------------------



Software Revision Number: On both receiver and transmitter, the software revision number is displayed on the LCD during the startup sequence if the default start screen is used. It can also be found in the “About” section of the user menu.



Receivers with the Tx-Link option installed will show this icon label on the blade where it meets the yellow upper housing.

Transmitters with the Tx-Link option installed will show this icon label on the upper corner of the housing. (Tx-Link is not available for the Loc-150Tx model transmitter.)

1.2 Distributors and Service Centers Closest to You:

Worldwide Sales Offices and Service Centers	
World Headquarters, United States of America	Central/South America and the Caribbean
<p>Vivax-Metrotech Corporation 3251 Olcott Street, Santa Clara, CA 95054, USA</p> <p>T/Free : 1-800-446-3392 Tel : +1-408-734-1400 Fax : +1-408-734-1415 Website : www.vivax-metrotech.com Email : SalesUSA@vxmt.com</p>	<p>Ventas para América Latina 3251 Olcott Street, Santa Clara, CA 95054, USA</p> <p>T/Free : 1-800-446-3392 Tel : +1-408-734-1400 Fax : +1-408-743-5597 Website : www.vivax-metrotech.com Email : LatinSales@vxmt.com</p>
<p>Canada</p> <p>Vivax Canada Inc. 41 Courtland Ave Unit 8, Vaughan, ON L4K 3T3, Canada</p> <p>Tel : +1-289-846-3010 Fax : +1-905-752-0214 Website : www.vivax-metrotech.com Email : SalesCA@vxmt.com</p>	<p>France</p> <p>Vivax-Metrotech SAS Technoparc - 1 allée du Moulin Berger, 69130 Ecully, France</p> <p>Tel : +33(0)4 72 53 03 03 Fax : +33(0)4 72 53 03 13 Website : www.vivax-metrotech.fr Email : SalesFR@vxmt.com</p>
<p>Germany</p> <p>Metrotech Vertriebs GmbH Am steinernen Kreuz 10a, D-96110 Schesslitz</p> <p>Tel : +49 954 277 227 43 Website : www.vivax-metrotech.de Email : SalesEU@vxmt.com</p>	<p>United Kingdom</p> <p>Vivax-Metrotech Ltd. Unit 1, B/C Polden Business Centre, Bristol Road, Bridgwater, Somerset, TA6 4AW, UK</p> <p>Tel : +44(0)1793 822679 Website : www.vivax-metrotech.com Email : SalesUK@vxmt.com</p>
<p>China</p> <p>Vivax-Metrotech (Shanghai) Ltd. 3/F No.90, Lane 1122 Qinzhou Rd.(N), Shanghai, China 200233</p> <p>Tel : +86-21-5109-9980 Fax : +86-21-2281-9562 Website : www.vivax-metrotech.com Email : SalesCN@vxmt.com.cn</p>	
International Distributors and Service Centers	
Australasia	China
<p>Vivax-Metrotech AUS Unit 1, 176 South Creek Road, Cromer NSW 2099, Australia</p> <p>Tel : +61-2-9972-9244 Fax : +61-2-9972-9433 Website : www.vivax-metrotech.com.au Email : sales@vxmtaus.com, service@vxmtaus.com</p>	<p>Shanghai Vimap Technology Co. Ltd. 9/F, Building 89, Xinhuiyuan, No.1122 Qinzhou North Road, Shanghai, China 200233</p> <p>Tel : 4000-999-811 Website : www.vimap.cn Email : info@vimap.cn</p>

2. Introduction

2.1 About this Manual

This handbook assumes some understanding of Cathodic Protection techniques. This manual covers the vLoc3-DM Receiver, 25-watt transmitter and 150-watt transmitter.

2.2 Overview of vLoc3-DM System

The vLoc3-DM (Defect Mapper) has been designed to:

- Identify the position of coating defects
- Identify shorts to other structures
- Help categorize the faults
- Help plan and prioritize remedial work
- Operate as a long line pipeline locator

The vLoc3-DM uses the latest locating and signal processing techniques to plot the current gradient of an industry-standard low frequency (3Hz or 4Hz) profiling current. The current is typically applied at CP (Cathodic Protection) stations, so the pipeline's disruption can be minimized.

The Loc-150Tx (150-watt) transmitter applies a signal current to the anode bed. The pipeline returns the signal via coating faults back to the transmitter. The transmitter is designed to be powered from CP stations, AC or external batteries. Note that the Transmitter Link option is not available for the Loc-150Tx Transmitter.

The Loc3-25Tx 25-watt transmitter is a portable version of the 150-watt transmitter. A custom rechargeable Li-ion battery tray powers the 25-watt transmitter.

The vLoc3-DM receiver is a non-intrusive measuring device to take measurements along a pipeline. These measurement results are displayed on the screen of the receiver. The measurements and data are logged into the receiver for downloading to spreadsheets or dedicated analysis programs. There is no need to carry extra logging and display devices.

An internal +/- 3m accuracy GPS antenna is included with the system. Alternatively, a Bluetooth-enabled GPS device can be linked to the vLoc3-DM receiver via a Bluetooth radio link. The GPS enables the user to generate real-time current gradient graphs and guides them back to the point of interest by highlighting the user's position on the graph. This feature is called the "walk back" feature. The system can also be integrated with other high-accuracy GPS systems and software packages.

Storing the results also has the benefit of facilitating the technique of comparative testing. Comparing the results from previous surveys of the same length of the pipe allows the Cathodic Protection engineer to establish coating deterioration trends.

The A-frame fault-finding accessory is used to locate the position of a fault accurately. An arrow points the user to the fault's position while quickly and efficiently graphing the fault signal's characteristic shape and magnitude on the receiver's display.

The A-frame is also used to undertake full ACVG surveys along a pipeline route. Results are stored with GPS data and real-time graphs generated on the vLoc3-DM screen.

Setting the vLoc3-DM to simultaneous mode allows the user to take ACVG and current profiles during just one simultaneous survey of the pipeline.

2.3 Planning a Survey

Surveys will vary greatly depending on the type of terrain, accessibility, condition of the pipeline, type of pipeline and coating type.

The first step of undertaking any survey should be to obtain information about the pipeline stretch to be surveyed. More work at this stage may well save time and effort later. Obtaining maps showing route information, CP stations, sacrificial anodes and cross bonding points will significantly help.

The transmitter should be capable of transmitting from one CP station to another, so although not necessary, plan to have the previous and after CP stations disconnected from the pipeline's stretch to be surveyed. Remember that the pipeline is not protected while the survey is being undertaken so CP stations' unnecessary downtime should be avoided.

Choose the survey interval to match the condition of the pipeline. In areas where the coating is inferior a survey interval of as little as 10m may be desirable. However, if the coating is in excellent condition and the distance between CP stations is many km, it may be better to choose a survey interval of as much as 200m. Taking measurements at large intervals will enable the surveyor to assess the pipeline's condition quickly and subsequently identify areas requiring further inspection at closer survey intervals or detailed analyses using the A-frame Fault Finder accessory.

3. vLoc3-DM Receiver Functions and Operations

3.1 vLoc3-DM Receiver Overview



1	vLoc3-DM Receiver (with low-frequency sensor foot attached)
2	Mini-USB cable
3	Li-ion battery
4	Charger
5	AA Alkaline batteries
6	Alkaline battery holder
7	Power cable for charger
8	vLoc3-DM Low-Frequency Sensor
9	Sensor Blanking Plate
10	User manual
11	Soft carry bag



1	Pushbutton keypad and display	7	Accessory socket and charging point
2	Model number & serial number	8	Expansion sockets for additional features such as the Bluetooth module
3	Battery retaining cover		
4	AA Alkaline battery pack/rechargeable battery pack	9	Receiver stem
5	Mini-USB port for data transfer and software updates	10	Sensor retaining screw
6	Battery compartment cover	11	Low-frequency sensor

3.2 DM Low-Frequency Sensor Foot

The device at the bottom of the locator tube is the DM low-frequency sensor foot. This device is used to detect the low-frequency component (frequencies between 3Hz and 8Hz). These are the vLoc3-DM current mapping frequencies. When the low-frequency mapping is not required, for instance, if the equipment is being used for pipeline locating but not defect mapping, the low-frequency sensor can be removed.

Removing the DM sensor foot will reduce the locator's weight and change how the logging is done. The logged frequency will then be the locate frequency selected and graphing will also use this frequency.

3.2.1 Removing the DM Low-frequency Sensor foot

Rotate the retaining screw on the bottom of the receiver stem counter-clockwise for ¼ turn. Grasp the low-frequency sensor and rotate it counterclockwise until it releases.



Now fit the blanking plate supplied by following the above instructions in reverse order.



IMPORTANT

Always install the blanking plate when the low-frequency sensor foot is not attached. There are critical contacts within the antenna tube that require protection. Failure to do so may void the warranty.



When setting the retaining screw on the side of the antenna tube, hand tighten only.

3.3 Charging the Receiver Batteries

The vLoc3-DM can be used with either alkaline batteries or an interchangeable rechargeable battery pack.



The central illuminated section within the battery icon indicates the amount of charge remaining.

Blue center indicates Alkaline batteries.

Green center indicates rechargeable batteries.

When batteries are low the remaining charge section becomes red and will flash.

Just before the shutdown the below symbol will be shown:



3 vLoc3-DM Receiver Functions and Operations

Rechargeable batteries are supplied with a mains charger that is specific to the batteries. Avoid using other manufacturers' chargers as these may damage the battery pack and result in overheating.

To charge the rechargeable batteries, first make sure the pack is inserted in the receiver battery compartment. Charging is done with the battery inside the receiver.



Connect the charger to the charging socket of the receiver. Connect the charger to the mains and switch it on. The LED indicator on the charger will illuminate red until the batteries are fully charged, at which time the LED will change to green.



WARNING

Rechargeable batteries are supplied with a mains or 12V DC charger. These are specific to the batteries. Only use the charger that is appropriate for the batteries in the product. If in doubt call the Vivax-Metrotech customer service department at +1(800) 446-3392. Failure to use the appropriate charger could damage the battery pack, locator and in extreme cases cause a fire.

Avoid charging the unit in extreme temperature conditions, i.e., below 0°C and above 45°C

Although Vivax-Metrotech batteries include all the required safety-related features, immediately discontinue the charger and battery pack's use if the battery pack becomes excessively warm. Return both to where they were purchased for investigation.

Always ensure batteries have at least a partial charge if storing for long periods without use.

Dispose of all batteries following your company procedures and or Federal/State and local regulations.

Never dismantle the battery pack, put them in a fire, or get them wet.

3.4 The vLoc3 Series Keypad

The grey color keys (3, 5, and 6) serve dual functions. You may have to **Short Press** by momentarily pressing the key or **Long Press** by pressing and holding the key until the desired function is shown.

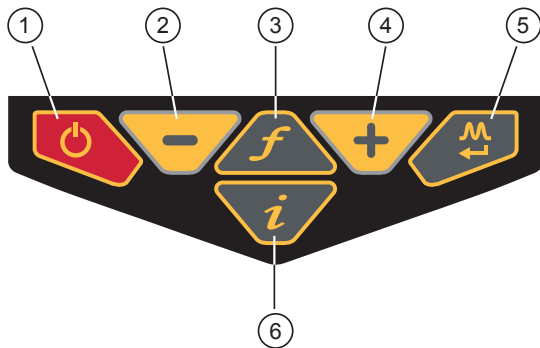

vLoc3 Series Keypad

1	On/Off
2	Reduce sensitivity and also scroll up when in User Menu
3	Select frequency Long press = show the pre-selected frequency table
4	Increase sensitivity and also scroll down when in User Menu
5	Enter Short press = change antenna response when in classic screen Long press = change the locate perspective
6	Information and Depth Short press = enter the information and logging screen Long press = enter the User Menu

Pushbuttons	Locate Screen	Measure Screen	Graph Screen
	On/Off	On/Off	On/Off
	Change frequency, long press shows frequency list	Not active	Auto scale when this icon is shown Delete when this icon is shown
	Short press for measure and long press for the user menu	Jump back to Locate Screen	Return to the Locate Screen
	Increase gain	Save and jump back to Locate Screen	Increase scaling
	Decrease gain	Reject and Jump back to the Locate Screen. Press to delete a log in memory	Reduce scaling
	Change antenna mode	Go to Graph Screen	Change scaling aspect (see next chart)

When in the graphing Mode/Screen the soft key operated by the key has the following functions as indicated by the changing icon:

Softkey icons in the Graph mode	Function
and	Scale the horizontal or and vertical axis
and	Zoom in on the horizontal or vertical axis
	Data is displayed on the left-hand side of the screen example:: Pressing the "f" key deletes the highlighted point.
	Press the "i" button to return to the locate screen.
	When the icon Autoscale icon is shown, press the "f" key to auto-scale.

3.5 The vLoc3 Series User Menu

The user-configurable vLoc3 series receivers can be customized to suit the user's preferences. The receivers have several features that can be switched on and off through the user menu.

This section covering the user menu is split into four subsections;

Setup – Covers the settings that are usually chosen and not often changed. Most of these settings apply to the locator's physical attributes such as language, sound, and measure units.

Operational – Covers the locate screens and locate perspective.

Features – Are optional modes and physical add-ons such as Bluetooth, Marker Locator Adapter, and other options that may have been ordered.

Informational – Covers the receiver's configuration, firmware version, and regulatory information.

It is recommended that the **Setup section** be done first. It will be easier to finish the receiver's setup if it is done in the native language.

To enter the user menu, press and hold the "i"  key, release the key when in the menu.

Note that where you see this symbol , pressing the enter button gives access to the sub-menu associated with this button.

To exit the menu or sub-menu, press the "i"  button.

Where the  icon is not shown, the enter button is used to scroll through the options of that feature.

Use the "+" and "-" buttons to scroll up and down through the menu.

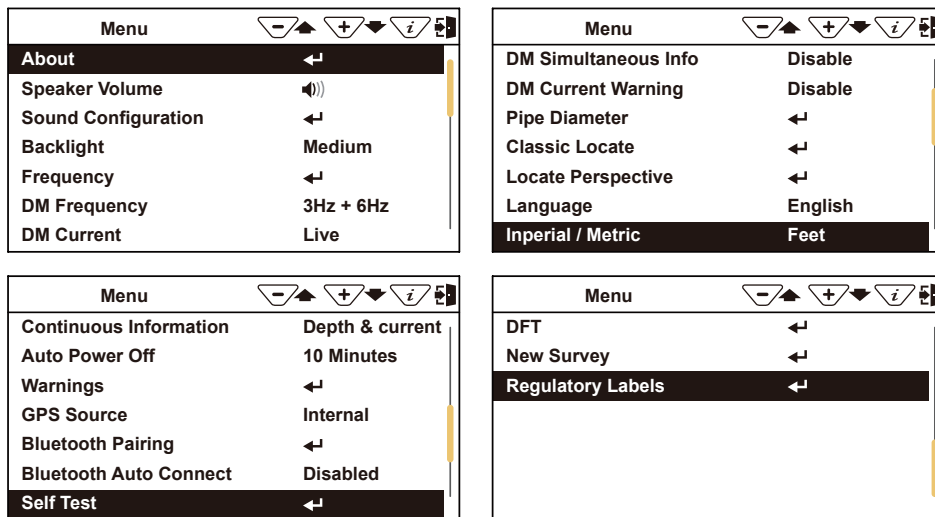

3.5.1 Setup - Receiver

Language – The receiver can be programmed in different languages. Repeatedly pressing the Enter key cycles through the list of available languages.

Speaker Volume – Repeatedly pressing the Enter key raises the speaker volume by three levels and then turns off the volume. When off  is displayed.

Backlight – Press the Enter key to change the backlight intensity to Low, Medium, High or Auto. The use of the "Auto" selection is recommended because the receiver has a built-in light sensor that automatically adjusts the backlight intensity to the surrounding lighting conditions. Auto-selection may improve battery life performance.

Sound Configuration - Changes the sound configuration of the locate modes. Use the Enter key to select **AM** or **FM**.

- **In active locate modes:**
 - Frequency Modulated (**FM**) Sound pitch changes with signal strength
 - Amplitude Modulated (**AM**) Sound volume changes with signal strength
- **In passive locate modes:**
 - Radio mode: **FM** or **Real** (Sound derived directly from the received signal)
 - Power mode: **FM** or **Real**

Imperial/Metric – Use the Enter key to select Imperial or Metric measurements for the depth readings.

Continuous Info – The locate screens can display a continuous reading of either depth, current, both or can be switched off. Use the Enter key to select your preference.

Auto Power Off – The unit can be set to switch off after a set time. Options are 5-minutes, 10-minutes or Never. Note that when the accessory A-frame is connected the timer defaults to “Never.”

3.5.2 Setup - Operational

Frequency - Press the Enter key to enter the Frequency sub-menu. Scroll up and down the table of available frequencies using the “+” and “-” keys.



Simplify the operation of the receiver by selecting only the frequencies applicable to your applications. To do this use the enter key to check the boxes on the right. Frequencies not checked will not appear on the locate screen.

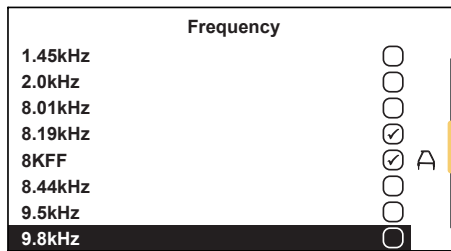

Note also that specific frequency options have an A-frame icon next to them. It indicates that these frequencies are selected to be used with the fault find A-frame.

DM Frequency - Use the enter key to select either:

- 3Hz
- 4Hz
- 3+6Hz
- 4+8Hz

DM Current - Use the enter key to select either:

Static: - Displayed DM current is the first measurement when entering the “Info” screen.

Live: - The displayed current is continually updated when in the “Info” screen.

DM Simultaneous Info - Use the enter key to select either:

Enabled: When enabled, pressing the “info” screen when the A-Frame is connected displays both the A-frame and the DM current. Saving the info screen saves both pieces of data.

Disabled: When disabled, pressing the “info” screen when the A-Frame is connected displays only the DM current and only the DM current is saved.

The icon  indicates that the depth of cover feature is active as below:

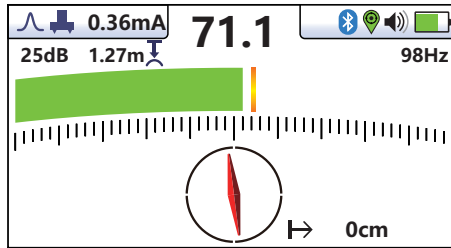

Re-enter the User Menu to check pipe diameter settings.

The pipeline diameter feature/depth of cover feature is enabled or disabled using the app "MyLocator3".



Certain frequencies have an A-frame icon next to them. This icon indicates that these frequencies are selected to be used with the fault find A-frame.

Classic Locate – This option is only shown if the menu is entered from the Classic Screen.

Use the enter key to reveal the list of options relating to the Classic Locate mode. Options are:

Classic Locate	
Peak	<input checked="" type="checkbox"/>
Peak With Arrows	<input checked="" type="checkbox"/>
Null	<input checked="" type="checkbox"/>
Broad	<input checked="" type="checkbox"/>
Delta Null	<input type="checkbox"/>
Omni Directional Peak	<input checked="" type="checkbox"/>
Omni Directional Broad	<input checked="" type="checkbox"/>

Locate Perspective – Enter this menu to select the graphical format that the locate data will be displayed. These displays are described further in the manual. The options are:

Locate Perspective	
Classic Locate	<input checked="" type="checkbox"/>
Vector Locate	<input checked="" type="checkbox"/>
Transverse Graph	<input checked="" type="checkbox"/>
Plan View	<input checked="" type="checkbox"/>
Sonde	<input checked="" type="checkbox"/>

3.5.3 Setup - Features

Warnings – Warnings relating to - Shallow cable, Overload, Overhead cable, and Signal Overload. Scroll down to the relevant warning and use the return button to select or de-select.

GPS Source - Use the Enter key to select the source of Internal or Bluetooth.

Internal - The vLoc3-DM has a factory-installed internal GPS module. It is low accuracy, typically +/-3m.

Bluetooth - If the Blue tooth option is selected, the vLoc3-DM can be paired by Bluetooth with a more accurate GPS. More on this is described later in this manual.

Satellite Information - Select this option using the Enter key to see the available satellite information.

Bluetooth Pairing (if installed) - This option allows the receiver to link with external devices such as data loggers or GPS devices with Bluetooth capability. Press the enter button to enter the Bluetooth pairing routine.

Bluetooth Auto Connect – When this option is enabled the receiver will automatically connect with any previously paired Bluetooth device.

Transmitter Link - (if installed) (not available for the Loc-150Tx Transmitter) This is a factory-fit option that must be requested at the time of ordering. The Loc3 series transmitters can be remotely operated from the vLoc3 series receivers. This feature requires the transmitter radio link option to be installed in both the vLoc3 series receiver and the Loc3 series transmitter.

Transmitter Control (if the Transmitter Link option was ordered) (not available for the Loc-150Tx Transmitter) - This option is shown if the Transmitter Link is installed and active. This option will control the functions of the transmitter.

DFT - Discrete Fourier Transform is a tool to help choose a frequency to apply to the target conductor. The DFT feature will aid the user with nearby interference that may affect the locate quality.

New Survey - Entering the Survey sub-menu causes a new survey initiated in the SD Card Data Logger.

DM Graphs are cleared so that a new survey is identifiable from older measurements.

Different Survey types can be selected as shown.

Navigating into this menu and selecting a survey type always causes a new survey to be registered, regardless of whether it is the same type as the previous log record.

Electric
Gas etc.
Communications
Potable Water
Reclaimed Water
Sewer
Temporary Survey
Proposed Excavation
Oil

3.5.4 Setup - Informational

About - This section holds the data about the locator, such as software revision, calibration data, etc.

Regulatory Labels - This section shows the required FCC ID and IC information.

Self-Test - The vLoc3 series receivers have a self-test feature that confirms the equipment is fit for use and that the calibration has not drifted from its expected settings.

3.6 Self-Test

The self-test feature must be run in an area free from interference such as overhead fluorescent lighting, large transformers, etc. Also, check that any nearby transmitters or sondes are switched off.

Select "Self-Test" from the user menu and press the "Return" button. Keep the receiver stationary while the test is running. After a short while the test will complete and the unit will report Passed or Failed.

	Self Test: PASSED					
		110.3	✓	✓	✓	✓
		110.3	✓	✓	✓	✓
		64.1	✓	✓	✓	✓
		110.3	✓	✓	✓	✓
		110.3	✓	✓	✓	✓
	64.1	✓	✓	✓	✓	
	Self Test: FAILED					
		109.6	X	X	✓	✓
		109.9	X	X	✓	✓
		64.3	X	X	✓	✓
		109.7	X	X	✓	✓
		109.9	X	X	✓	✓
	64.5	X	X	✓	✓	

Examples of the self-test results

If the receiver fails the self-test try it again in an area with less interference. If it continues to fail return the unit to Vivax-Metrotech or one of its approved repair centers for investigation.



Note that the vLoc3-DM low-frequency sensor foot is not tested during the self-test. To test this item use the unit over a known pipe and check measured values fall within the published specification.

3.7 Warnings and Alerts

Warning symbols accompanied by an audible sound and vibration in the handle unless configured otherwise in the MyLocator3 desktop app. Warnings can also be switched off in the setup menu.

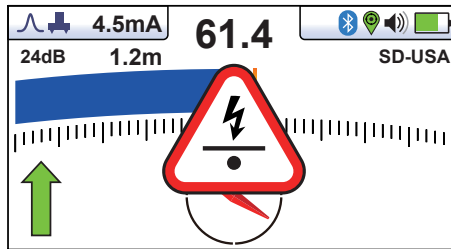

3.7.1 Warning and Alerts Descriptions

ALERT	Alert Description
	DM current warning - will appear in the Info screen when the current change exceeds a pre-determined value.
	Signal Overload - is usually caused by operating close to power transformers or being close to a transmitter in Induction mode. Moving away from the interfering signal will cure the problem.
	Shallow Cable - alerts indicate that the locator has detected a possibly less than 15cm (5.9-inch) deep cable. Proceed with caution.
	Swing Alert - indicates that the operator is swinging the locator excessively resulting in misleading information. When sweeping the locator across the direction of the line try to keep it vertical as this will improve its accuracy.
	Overhead Cable - alerts indicate that the source of the signal is mainly radiating from above. This alert is usually caused by the signal traveling along overhead cables.

3.7.2 DFT (Discrete Fourier Transform)

DFT is a tool to assist in choosing a frequency to apply to the target conductor. The DFT feature will aid the user with nearby interference that may affect the locate quality.



***Note the DFT feature should not solely be used to determine which frequency to apply. ALWAYS follow the appropriate safety requirements mandated by safety legislation, safety practice or your company's safety procedures when applying a locate frequency to a conductor.**

1. To perform a DFT assessment verify any nearby transmitters are powered off to avoid additional signal frequency disturbance.
2. Select your preferred frequencies from the frequency menu. These selected frequencies will be assessed in the next few steps.

3 vLoc3-DM Receiver Functions and Operations

Frequency	
128Hz	<input type="radio"/>
480Hz	<input type="radio"/>
491Hz	<input checked="" type="radio"/>
512Hz	<input checked="" type="radio"/>
577Hz	<input type="radio"/>
815Hz	<input type="radio"/>
982Hz	<input type="radio"/>
1.02kHz	<input type="radio"/>

3. Navigate to the main menu and scroll until you see DFT. Select DFT by pressing the enter key.
4. Once the option is selected the receiver will automatically assess the user's preselected frequencies.
5. The receiver will scan all available frequencies and display a progress bar, and the list of frequencies assessed will be displayed. The frequency under test is shown on the top line.

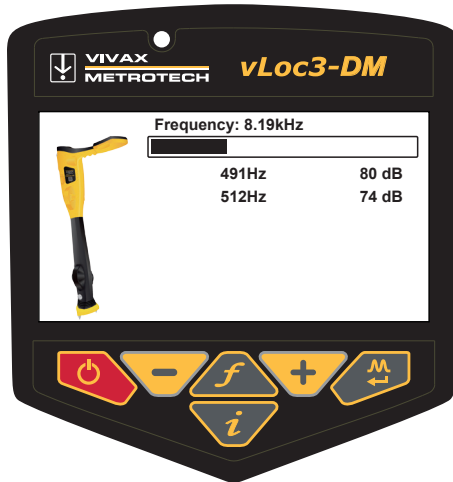

6. A numerical value ranging from 0dB to 140dB will be presented next to the frequency list with 140dB being the least possible interference detected and 0db with the largest amount of possible interference.
7. The results are ranked from the least interference possible at the top to the largest amount of most possible interference at the bottom.
8. In this case, 491Hz with 80dB is the frequency with the least interference detected by the receiver.

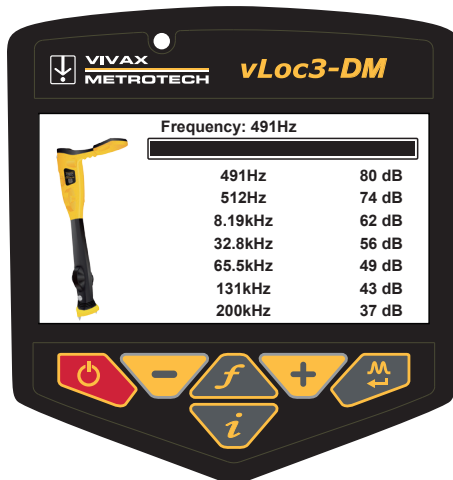

* Sometimes even if the frequency results appear to have less interference, it still does not make it the best choice to locate certain utilities. The type of conductor, current output, resistance, and signal bleed over may still affect the locate.

3.8 vLoc3 Series Locate Modes and Screens

Note - The vLoc3 series user interface is under continual development. The screenshots described here may differ slightly from your screens.

The vLoc3 series receivers give the user a choice of locating screens.

The choice of the screen depends on the application and user preference. These screens are:

- **Classic Locate**
- **Vector Locate**
- **Plan View Locate**
- **Transverse Locate**

First we will explain the functions of the “Classic Screen,” as familiarity with this screen will help understand others' functions.

3.8.1 The Classic Screen Status Bar

The Status Bar runs across the top of the LCD. The status bar shows which modes and features of the locator are active.

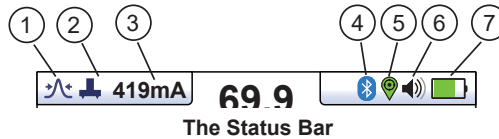

1	Antenna configuration (described later in the manual).	4	Bluetooth status: Grey indicates Bluetooth is not installed. Black indicates installed but not active. Blue indicates active and paired.
2	This icon is shown in this position when the low-frequency sensor is fitted and active.	5	GPS status (Green indicates GPS signal lock).
3	Continuous Signal Current and Depth of the target line. (can be set to show continuous signal current, continuous depth, or both).	6	Speaker volume setting.
		7	Battery type and remaining charge.

3.8.2 vLoc3-DM Receiver Classic Screen

The Classic Screen – This screen has all the functions usually seen on a typical cable locator. The main functions being:

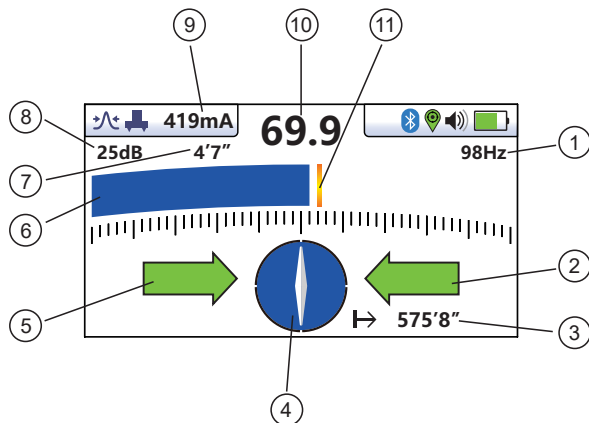

1	Locate frequency
2	Left/Right locate arrows
3	Distance from last recorded reading (requires GPS option active)
4	Compass Line direction indicator
5	Left/Right locate arrows
6	Locate signal bar graph: Green indicates low distortion, Blue indicates minor distortion, and Red indicates excessive distortion.
7	Depth to the center of the pipe
8	Gain Setting
9	Locate tone current (not to be confused with DM current)
10	Percentage of signal strength (mirrors #6, the bar graph)
11	Peak level indicator

3.9 Classic Locating Modes (Response)

The vLoc3-DM receiver has an array of six antennas and these can be toggled through different configurations (modes) to provide different responses to the signals radiating from buried utilities. The modes are:

Peak Mode

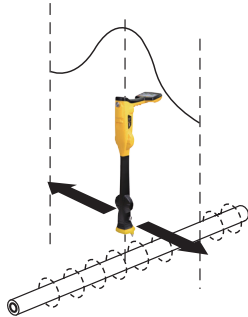

Two horizontal antennas provide a “Peak” or maximum signal response over the buried line.

This is an accurate locating method as both horizontal antennas are used to provide a clearly identifiable peak. It is also less prone to the effects of signal distortion.

The Peak Level Indicator on the bar graph indicates the point of the largest signal detected allowing the user to return to this point quickly.

The compass (line direction indicator) aligns itself parallel to the cable (available in Active modes).

Broad Peak Mode

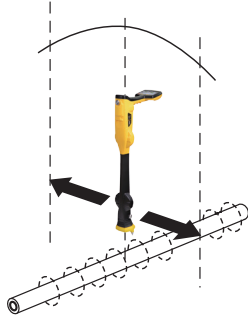

A single horizontal antenna provides a “Peak” or maximum signal response over the buried line.

The result is a less defined peak than the twin horizontal antenna peak mode. This mode is useful in deep lines because using a single antenna can boost the received signal.

The compass (line direction indicator) aligns itself parallel to the cable (available in active modes).

Null Mode

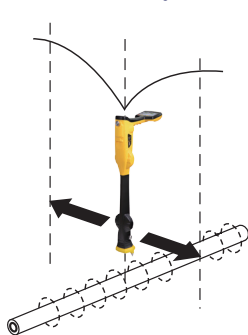

The vertical Null antennas receive a minimum or “Null” response over the buried line.

The null mode works well in uncongested areas but is more prone to inaccuracies due to the effects of field distortion. This effect can be used to detect distorted fields by comparing the null mode position with the peak mode position. If the two positions do not coincide, this indicates possible distortion. The greater the difference, the greater the distortion.

Left/right arrows indicate the direction to move the receiver to locate the buried line's position while in the null mode.

The compass (line direction indicator) aligns itself parallel to the direction of the cable (available in active modes).

Delta Null

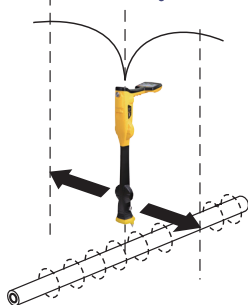

The Delta mode uses dual vertical antennas. The “Delta Null” has the advantage that it provides a sharper response than the null mode and is less affected by distorted fields. All other functions are the same as the null mode.

Delta mode uses dual null antennas to minimize the offset effects of field distortion. This mode tends to be more precise than the Null mode.

Peak with Arrows Response Mode 

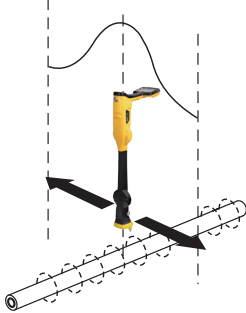

The "Peak with Arrows" mode operates in the same way as the peak mode. It gives the largest meter deflection when directly over the line. However, the left/right indication arrows are also displayed. The arrows indicate the direction to move the receiver to locate the position of the buried line.

Note:

If the arrows indicated a different position for the cable than the peak bar graph position, this indicates the possibility of a distorted field. Check by taking a depth reading on the ground and then lift the cable locator to a known distance such as 1m (3ft). If the depth does not increase by this amount, it confirms a distorted field, and the data should be treated with caution.

Omni Peak Response Mode 

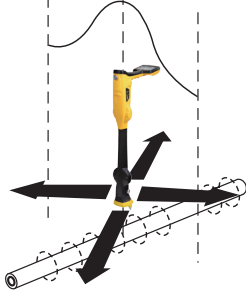

The two double-ended arrows around an icon mean that the line is detectable regardless of locator blade orientation.

It is very useful for quickly checking an area for buried lines using a grid search as one sweep will catch all locatable lines. In the classic screen, the Omni feature is available in the "Peak" and "Broad peak" modes.

Information Pushbutton  **(Depth & Current) (Info screen shown with the low frequency sensor removed)**

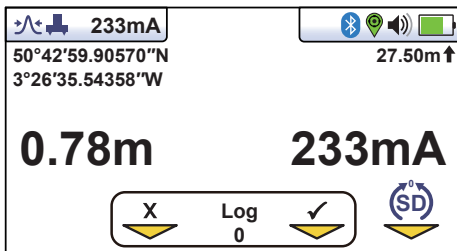

A quick press of the "i" (information) pushbutton will display the depth and signal current information in a locate screen.

The top left of the display shows longitude/latitude positional information. To the top right is the height above sea level. This information will only appear when the receiver is paired with a GPS module that is receiving a signal.

It is also possible to save the data to the internal memory; see the "Datalogging" section of this manual.



IMPORTANT

When locating a utility the depth and current measurements should only be taken with the bottom of the receiver standing on the ground and directly in line with the buried utility.

When in the Omni direction mode , the orientation is not important.

The accuracy of depth and current readings depends on the quality of the radiated signal being located. If the signal is symmetrical (undistorted), the depth reading will be accurate within +/- 5% of the actual depth. If the signal is distorted, depth readings will be less accurate. When taking depth measurements always hold the receiver at 90° to the ground.

3.10 Alternative Locate Screens

As previously mentioned the vLoc3 series receivers have alternative locate screens. The following section describes the operation of these screens. It is left to the user to decide which is the best screen for a particular application. To scroll through the available screens use a long key press on the "return" key.



3.10.1 The Vector Screen

The Vector Screen shows a cross-sectional view through the ground. A plan view is also shown to help orientate the user over the line. The Vector Screen is beneficial where access directly over the line is not possible. The depth and horizontal displacement distances are shown even when not directly over the line.

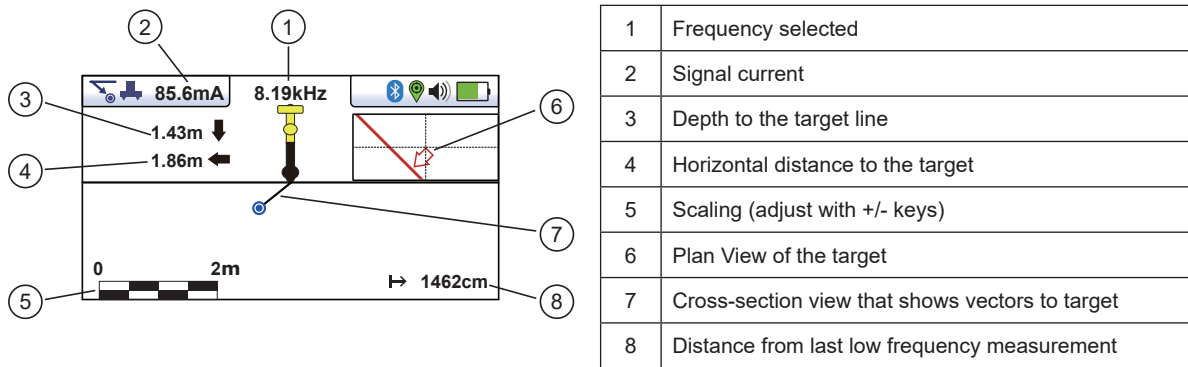

Using the Vector screen

1. Apply the signal to the target line in the usual manner and select the Vector screen using a long press on the "return" button until the desired screen appears.
2. Position the locator near the position of the target line. Use the Plan View (6) screen to help guide you toward the target line. You can imagine that the plan view is giving you a view under the ground.
3. Position yourself so that the red target line is pointing forward/back and is in the center of the screen.

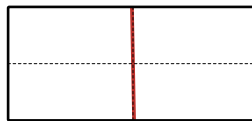

4. If the target is off the screen an arrow will appear on the screen to help direct you to the target line.

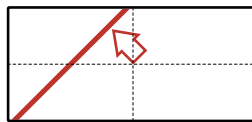

5. The cross-sectional section of the screen will respond as the target is approached. Use the + and – keys to alter the scaling if necessary.

3 vLoc3-DM Receiver Functions and Operations

6. There is a black line leading from the locator icon to the target line. The blue dot represents the target. Around the dot is a circle. The size of the circle indicates a confidence factor. The larger the circle the less confident the indicated position. Generally the actual position of the line will be within the confidence circle.

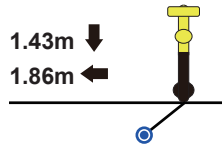

The color of the confidence circle also changes depending on the degree of confidence:
Green - Low distortion/high confidence.
Blue - Minor distortion/medium confidence. Proceed with care.
Red - Excessive distortion/low confidence. Treat all data and measurements with caution.

7. Notice that vertical and horizontal distances from the target line are displayed.

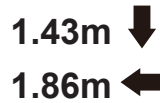

These must not be mistaken for the distance diagonally to the target such information is not displayed. The vertical distance is the actual depth from the bottom of the locator. The advantage of this is that the target's depth and position can be determined without being directly over the target line. So in the event of an obstruction at the measuring point data can still be gathered by placing the locator on one side of the target.



IMPORTANT

When taking Low Frequency measurements (ie 3 or 4Hz current measurements) it is important to be directly over the line.

3.10.2 The Transverse Plot Screen

Using the Transverse Plot screen

The Transverse Plot screen is used to analyze the field shape at a particular location enabling the user to better feel for the data's reliability.

Two plots are generated simultaneously.

- Peak response
- Null response

In non-distorted fields, the peak and null positions should coincide, and the shape of the fields should be symmetrical about the centerline. The picture below shows a slightly distorted field.

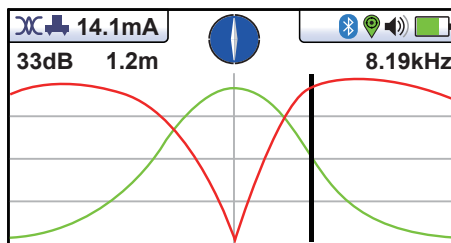

To take a plot first locate the target using one of the other locate screens. Now select the Transverse screen by a long press of the return button. Repeat this until the Transverse screen appears.

Position yourself to one side of the line so that the field markers are just on the screen. You will see that the lines automatically remove themselves after a few seconds. Clear the screen by pressing the “-” button. Now walk across the target line at a steady pace until you are on the other side of the target line. Immediately press the “+” button to save the plot on the screen.

It is still possible to walk back over the target locating the line's position in the transverse screen while still retaining the saved screen.

3.10.3 The Plan View Screen

The Plan View screen shows a picture as if you were viewing the line from above ground. When the red line is in the center and pointing forward/back you are directly over the line and pointing in the line's direction.

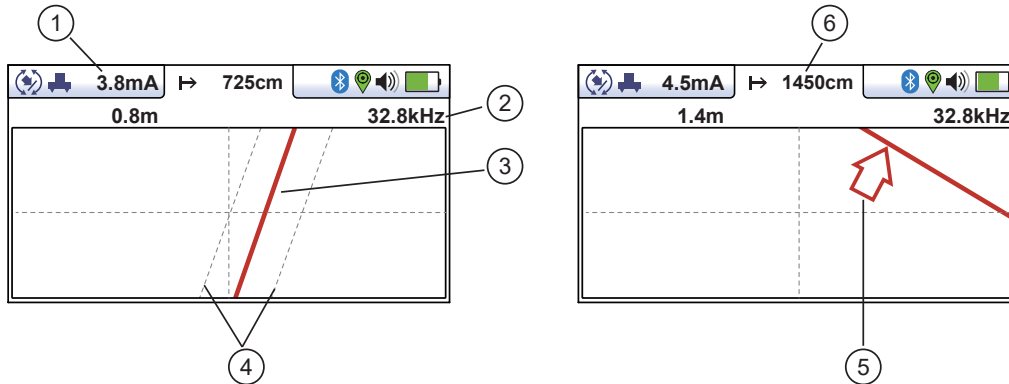

1	Depth and current readings	4	Lines of confidence (closer these are to the target line indicates more confidence)
2	Frequency selected	5	Arrow indicates the direction to move towards the line. It only shows when the distance to the target line is far away
3	Target line	6	Distance from last low frequency measurement

Using the Plan View screen

1. Apply the signal to the target line in the usual manner and select the Plan View screen by a long press on the return button until the desired screen appears.
2. Position the locator within the approximate position of the target line. Use the Plan View to help guide you toward the target line. You can imagine that the plan view is giving you a view into the ground.
3. Position yourself so that the target line is pointing forward/back and is centralized on the screen.

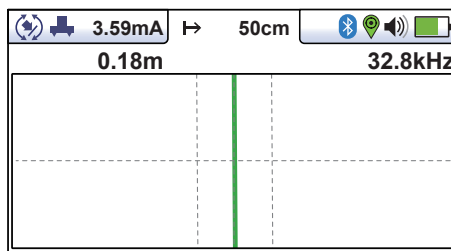

“Tram” lines on either side of the line indicate an area of confidence. The closer the tram lines are together, the greater the confidence.

In addition to the tram lines the color of the target line also changes depending on the degree of confidence:

Green: - low distortion/high confidence.

Blue: - Minor distortion/medium confidence, proceed with care.

Red: - Excessive distortion/low confidence. Treat all data and measurements with caution.

3 vLoc3-DM Receiver Functions and Operations

4. If the target is off the screen an arrow will appear on the screen to help direct you to the target line.

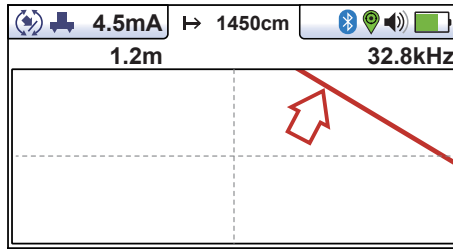

5. As long as the locator is detecting a valid signal, the depth (or current) will be available regardless of locator orientation, i.e., the locator does not need to be aligned with the target line in the forward back orientation. It is recommended in this mode. The current is always displayed as the signal may bleed off onto other services. Regular checks on the signal current, i.e., checking for large changes, will ensure the correct line is detected.

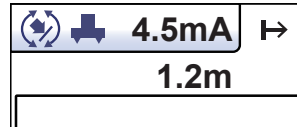

6. A short press on the info button will display the information screen. More information relating to the information screen is described in a previous section "Information Pushbutton (Depth & Current)."

4. Using the vLoc3-DM Receiver

4.1 Passive Locating



The compass indicator is not active in passive locate modes.

Passive locating refers to the process of detecting signals that naturally occur on pipes and cables. These tend to fall into two categories, radio signals and power signals.

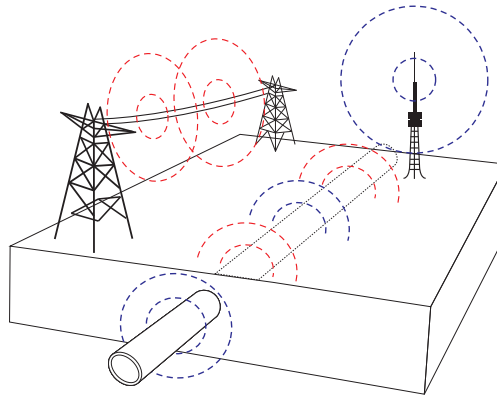

Radio signals - Low-frequency radio transmitters create radio signals. These are used for broadcasting and communications and are positioned throughout the world. As the frequencies are very low the signals tend to penetrate and hug the Earth's curvature. When the signals cross a long conductor such as a pipe or cable the signals are re-radiated. It is these re-radiated signals that the Radio mode can detect.

Power signals - Are created by mains power running in the supply cables. These signals are 50 or 60Hz depending on the country. For instance 50Hz Power is used in the UK while 60Hz Power is used in the USA. When electrical power is distributed throughout the network some power finds its way back to the power station via the ground. These stray currents can jump onto pipes and cables and also create power signals. Note that there has to be an electrical current flowing to create a detectable signal. For instance, a live cable that is not in use may not radiate a detectable signal. Also a well-balanced cable, i.e., the same current flowing in live and neutral will cancel out and may not create a signal. In practice, this is unusual as there are usually enough imbalances in the cable to create a good detectable signal.

4.1.1 Detecting Power Signals

1. Use the "f" button to put the vLoc3 receiver into the "Power mode." Notice that the antenna mode indicator will be showing "Peak" or "Omni peak," as these are the only options in the passive modes.

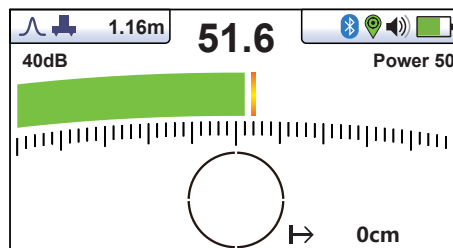

2. Hold the vLoc3 receiver vertically and away from likely positions of cables or pipes.
3. Adjust the sensitivity using the "+" and "-" buttons so that the bar graph reading is just starting to show some movement. Note that the compass feature is not available for the Power or Radio modes.

4 Using the vLoc3-DM Receiver



Note that there will be no sound from the speaker until the meter reading is above approximately 10% of the full scale.

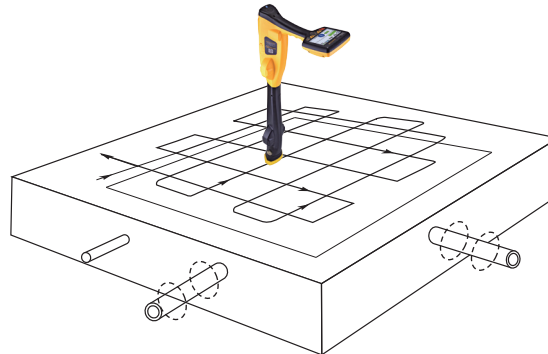

4. Keeping the vLoc3 receiver vertical walk across the area to be checked keeping the orientation so that the blade is in line with the direction of walking (See diagram above). If using the Omni Peak mode the orientation of the locator is not essential.
5. Continue in a grid across the area.
6. If the meter reading starts to increase, carefully move the locator side to side to detect the maximum signal. Use the peak level indicator to help confirm the correct position.

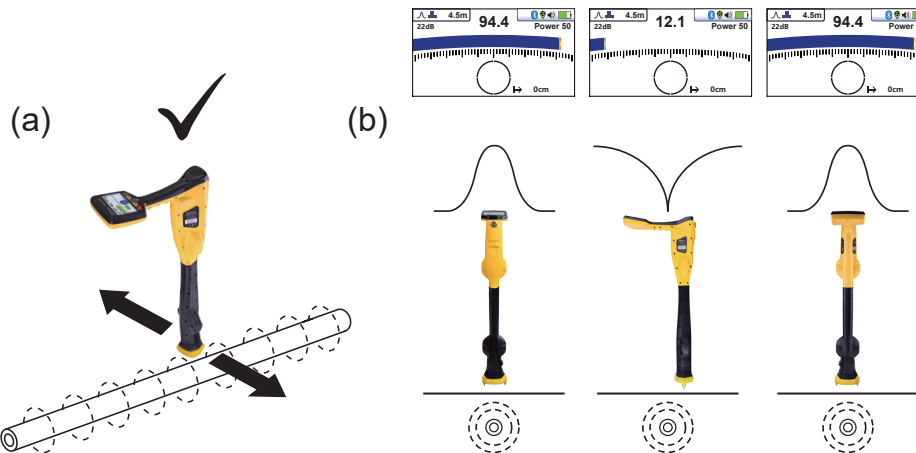

7. Rotate the vLoc3 receiver on its axis to obtain the maximum signal. The vLoc3 receiver is now directly over the line and with the blade across the line. If using the Omni-Peak mode there will be no change so switch to Peak mode if the direction is required.
8. The direction can also be found by rotating until the smallest signal is detected. The blade is then in line with the cable/pipe.
9. Continue to locate the line's position at regular intervals until its course is known throughout the target area.

4.1.2 Detecting Radio Signals

1. Locating radio signals is very similar to detecting power signals as they are both passive signals.
2. Hold the vLoc3 receiver vertically and away from likely positions of cables or pipes.
3. Adjust the sensitivity control so that the bar graph reading is just starting to show some movement. Now follow the procedure described above in the power mode section.

4.2 Active Locating - Applying the Locate Signal using the Loc3, 25-Watt Transmitter

Active locating uses a transmitter to apply a precise frequency to a pipe or cable, then uses a receiver turned to detect the signal being radiated at that precise frequency. Active location frequencies can be applied by direct connection or signal clamp. This is further explained in the following sections.

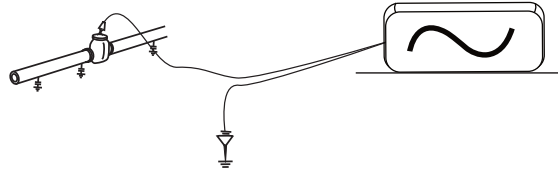

Unlike passive detecting, active locating has the benefit of the operator controlling the signals and can be more specific about what line is detected. Passive signals are also not always present on a line so using active signals ensures more lines are detected.

Choosing the correct frequency depends on the application and the environment. As a rule start with the lowest frequency you have available. Lower frequencies travel further with less bleed off onto nearby utilities than higher frequencies.

When using the signal clamp with the Loc3-25Tx (25-watt transmitter), the clamp frequencies available are limited between 8kHz and 10kHz.

A transmitter is required to apply a locate signal. Depending on the transmitter model the transmitters locate signal can be applied by direct connection or transmitter signal clamp.

4.2.1 Direct Connection

This method involves making an electrical connection to the cable or pipe.



WARNING
The direct connection leads are not designed for connection to live cables.



WARNING
Do not touch metal parts of the connection clips when connecting to the line or when the transmitter is on.

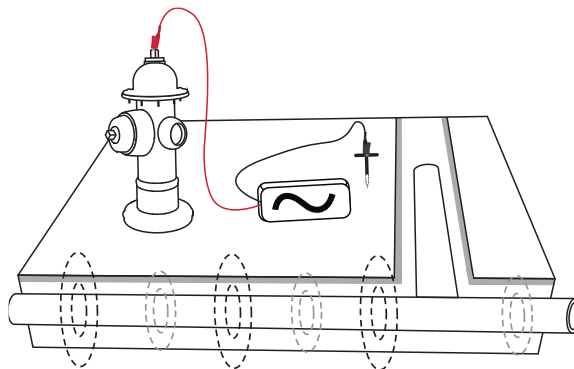

WARNING
Only authorized personnel should make connections to cables.

To make a direct connection plug the direct connection leads into the transmitter. Insert the ground stake into the ground a few meters perpendicular to the line. Connect the black lead to the ground stake. Now take the red lead and connect to the target line.

4 Using the vLoc3-DM Receiver

Switch on the transmitter by pressing and holding the on/off button down for a couple of seconds. Select the desired frequency depending on the application. Check for a good connection by either noting the mA output on the LCD or noting the change in tone rate when disconnecting and then reconnecting the red lead.

Always start with low output and increase the output if the received signal is not strong enough. Setting the output to high when it is not required may result in some of the signal bleeding off onto other services and will drain more power than necessary from the battery.

It is sometimes impossible to find a suitable projection to apply the connection clip to a ferrous material. If this is the case use a magnet to contact the line and then clip the red clip to the magnet. A good example of this is to make a connection to a street lighting circuit. Usually it is the practice to connect the sheath of a lighting cable to a street lamp's metallic inspection cover. Making a connection to the inspection plate will energize the cable via the plate and sheath. Usually, there is no projection on which to clip so using the magnet on the plate provides a suitable clipping point.

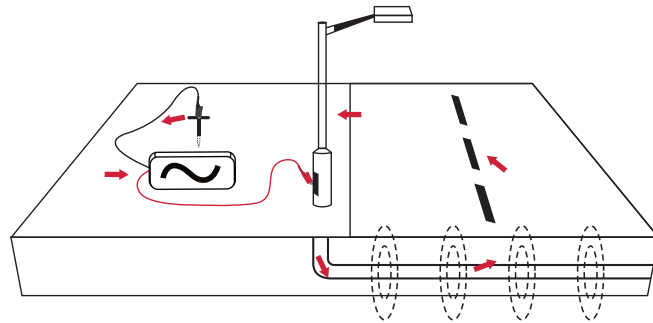

4.2.2 Transmitter Signal Clamp (25-watt transmitter)

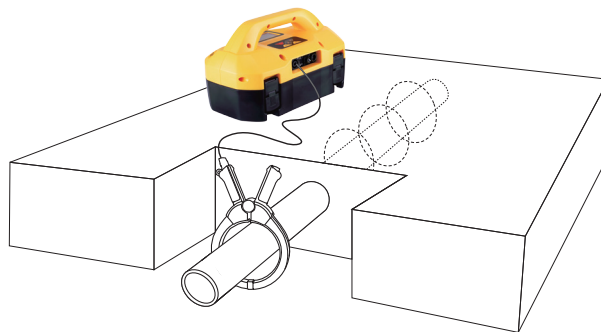

The **Loc3-25Tx, (25-watt transmitter)** has clamp frequencies from 8kHz to 10kHz.

It is impossible to gain access to a cable in some situations or it is not safe to do so. In such cases the signal clamp provides an efficient and safe method of applying a locate signal.

Note that for best results the cable should be grounded at both ends. The clamp should be fully closed for optimal current induction. A small amount of current will still be induced if the jaws are open.

When clamping around a cable make sure the clamp is placed below the grounding point as shown below.

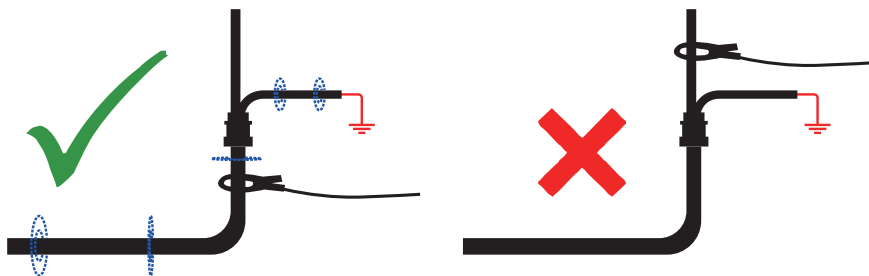

4 Using the vLoc3-DM Receiver

When applying a clamp close to a grounding point where multiple grounds or a grounding bus exists, ensure that you place the clamp around the target line and not to the ground bus/other grounds. Doing this will help focus the applied signal on the target line.

Clamp Extension Rod

A useful accessory to the clamp is the extension rod:

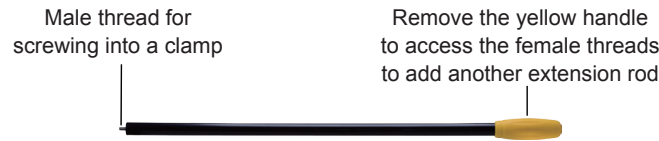

The extension rod is fitted with a 10mm threaded male stud. This male thread screws into the handle of the signal clamp to extend the distance of the clamp. This helps in areas with difficult access such as in manholes or trenches. (not to be used on uninsulated overhead power cables).

The extension rod is fitted with a female thread in the handle. The female thread allows the rods to be joined together to extend the range. To access this thread, slide the yellow handle off the rod.

To operate the clamp jaws when attached to the rod gently pull on the clamp cord which will open the jaws. Release the cable to close them.



WARNING

Always follow the appropriate safety requirements mandated by safety legislation, safety practice and your company's safety procedures when applying a clamp (coupler) to a cable.



BEWARE that when placing a clamp around cables carrying high current the clamp may vibrate, jump or close violently due to induced current from the target cable.

High voltages can be induced back onto the clamp and be present at the clamp's plug-in in some situations. Safety practices should be followed at all times when clamping around live target lines!

Always ensure the clamp is connected to the transmitter before clamping around a line.

4.3 Locating a Pipeline



There are several antenna configurations available and each has a particular response. However, for simplicity the method below uses the generic "peak with left-right arrows."

Connect the transmitter to the pipeline to be surveyed as instructed in the transmitter user manual. Switch on the receiver and select the frequency to match the frequency selection on the transmitter. Typically, this is 3/6/128Hz in 50Hz environments and 3/6/98Hz for 60Hz environments. Stand approximately 10 to 20 meters/yards from the transmitter and over the pipe's suspected position. Stand facing the transmitter and with the handle and display pointing at the connection point.

4 Using the vLoc3-DM Receiver

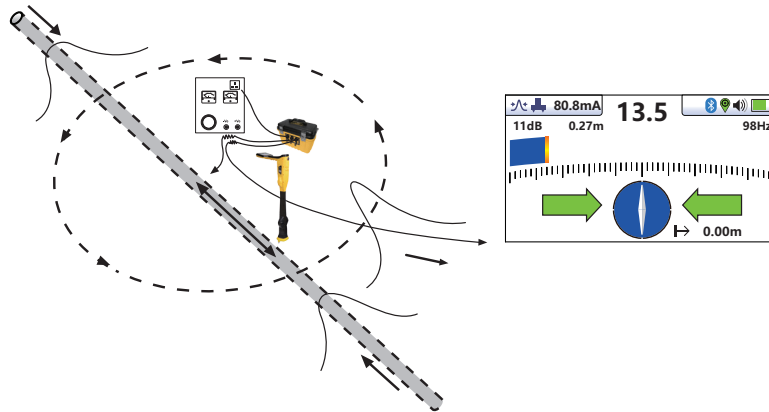

Keeping the receiver pointing at the connection point walk around the connection point for a full 360 degrees. The reading on the receiver signal strength meter will rise and fall as it passes over:

- the two pipe locations (forward and backward)
- the cable running to the anode bed

It will be necessary to adjust the receiver's sensitivity to keep the signal strength within the signal strength scale. If the signal is very low on the scale pressing the "+" pushbutton will adjust the gain so the signal strength is approximately 50% of the scale. If the signal goes over the top of the scale press the "-" pushbutton to return it to approximately 50%. Subsequent pressing of the "+" or "-" pushbuttons will increment the gain.

Notice that as the pipe is neared the left/right arrow will point to the pipe's position and the pipe directions indicator will align itself with the direction of the pipe.

4.4 Pinpointing

Before measurements are taken it is necessary to pinpoint the pipeline precisely. To do this use the following steps:

- Rotate the locator so that the compass (line direction indicator) is pointing north/south.
- Move the locator in the direction indicated by the arrow. Stop when the arrow changes to the opposite direction.
- Adjust the gain by pressing the "+" or "-" pushbuttons so that the bar graph reads approximately 50%.
- Find the largest signal by moving the receiver side-to-side over the suspected position of the pipeline, see:
 - (a) Stop at the largest signal. (note that the left/right arrows will help in this process, but the largest bar graph reading gives a truer indication of the actual pipe position). Now rotate the receiver until the largest signal is found, and the line indicator is pointing at the north and south position. Note the color of the bar graph. The color indicates field distortion. **Green** = little or no distortion, **Blue** = moderate distortion, continue with care, **Red** = excessive distortion, do not trust results.
 - (b) The receiver is now over and the handle is in line with the pipe.

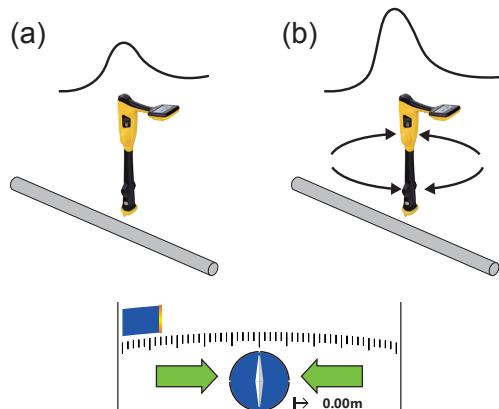



The anode bed cable will probably generate the largest signal and current reading. Confirm which is which by taking DM current readings and noting the current direction. The currents on the pipe will be flowing toward the transmitter. The current on the anode cable will be flowing away.



The sum of the currents on the two pipe locations should be close to the transmitter's current. If they are not, it may be that there is a fault at the connection point or that the current flowing on the anode bed cable is interfering with the signal from the pipe. To confirm this take readings a good distance from the connection point. Be aware that the anode bed cable very often runs along the same trench as the pipe for some distance and will affect the readings.

4.5 Taking Depth and Current Readings (Information Screen)

To take measurements it is first necessary to pinpoint the pipe as instructed in the previous Pinpointing section.

Next, hold the receiver on the ground vertically and with the handle in line with the pipe and your back to the transmitter. Keep the receiver very stationary and press the “I” pushbutton. The display will show the following screen while the measurement is made.

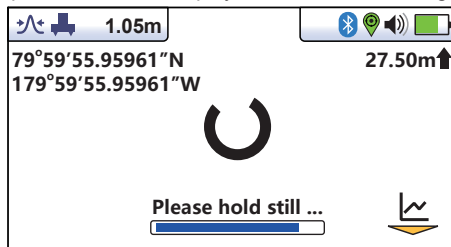

After approximately two seconds, the rotating circle and progress bar will be replaced with a display similar to the below.

1	Depth Reading
2	DM current direction
3	Do not log results and return to the locate screen
4	Number of logs made
5	Distance from last logged DM current point. If no GPS lock, this defaults to 10m.
6	Log results and return to the locate screen
7	Enter Graph screen to review results
8	vLoc3-DM Mapping Current
9	DM current warning. It's only shown if it has dropped from the previous value more than the pre-defined value.

4.6 Storing the Results



The vLoc3-DM current reading will continue to be updated approximately every second unless “Static” is chosen in the User setup of “DM Current.” This is done so that fluctuations in readings can be identified, allowing the user to wait until stable readings are shown before recording the result.

Pressing the “+” pushbutton while the measurement is being displayed will save the results to the next available internal log location and return to the Locate Screen.

4.7 Clearing the log

The data log can also be deleted from the info screen. From the Info screen, press and hold the “ - ” key. The message below will be shown.



Press the “+” key to confirm. The locator will ask again “Are you sure?”. Press the “ - ” key to delete or the “+” key to cancel the deletion and return to the locate/accessory screen.

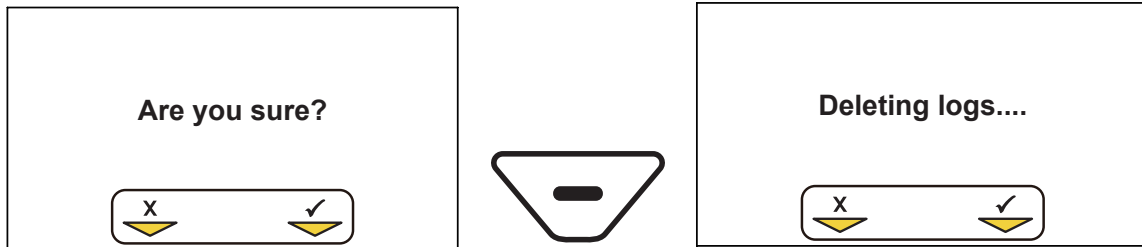



4.8 Graphing results on the screen

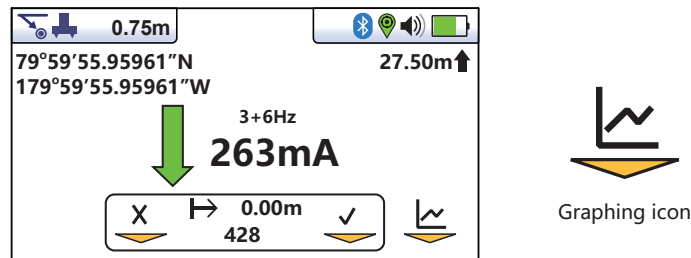

The vLoc3-DM has an onscreen graphing facility. Access to this facility is through the info screen. Press the “enter” key when in the “Info” screen.

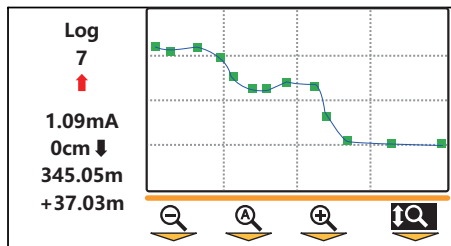





The graphing screen is displayed below:

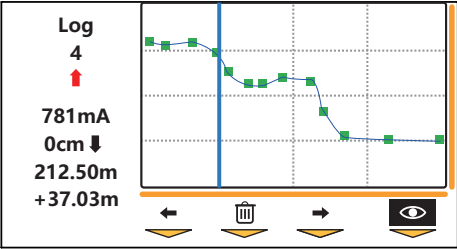

When in the graphing mode/screen the soft key operated by the  key has the following functions as indicated by the changing icon:

Softkey icons in the Graph mode	Function
	Horizontal Scroll – Shifts the horizontal axis. Use the left and right soft keys to shift the horizontal axis.
	Vertical Scroll – Shifts the vertical axis. Use the up and down soft keys to shift the vertical axis.

	<p>Horizontal Zoom – Allows the horizontal axis to be zoomed. Use the “+” and “-” soft keys to zoom the horizontal axis.</p>
	<p>Vertical Zoom – Allows the vertical axis to be zoomed, use the “+” and “-” soft keys to zoom the vertical axis.</p>
	<p>Review Mode - Use the left/right soft keys to highlight a point of interest, as indicated by the blue line. Data is displayed on the left-hand side of the screen example:</p> <div data-bbox="603 497 1062 746" data-label="Figure">  </div> <p>Pressing the “f” key deletes the highlighted point.</p>
	<p>Delete – Appears in the center soft key and is used to delete unwanted recorded points.</p>
	<p>Auto Scale – Appears in all graphing screens except the review screen. Pressing this key auto-scales the graph in either vertical or horizontal plains depending on the axis chosen.</p> <p>When the Auto Scale icon is shown press the “f” key to auto-scale.</p>

Press the “f” button to return to the locate screen.

4.9 The Walk-back feature

When in the graphing mode and receiving a valid GPS lock (except the “Review” screen), the graph will have a vertical line indicating the position of the locator along the pipeline.

While undertaking the survey the vertical line will be at the end of the graph.

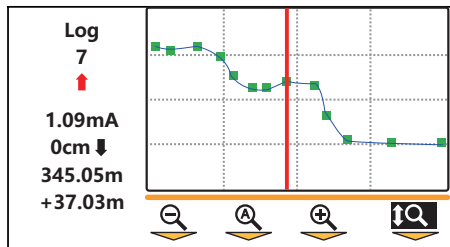

If the operator walks back along the pipeline the cursor will alter, indicating the operator's position. Now the operator can return to the point of interest without having to repeat the survey.

The vertical line color will change depending on how close the operator is to a surveyed point. The color codes represent distances as below:

- Green ⇔ Less than 10m from measurement
- Orange ⇔ Less than 50m from measurement
- Red ⇔ Greater than 50m from measurement

4.10 Signal Direction Precision Identification

When a transmitter is connected to a target line the signal travels along it and finds the easiest way to travel back, usually via the ground and ground stake. However, the signal will often travel back along adjacent cables or pipes as these can offer an easier route.

As a result multiple signals radiate from cables and pipes in the area making it difficult to identify the target line. These return signals are typically traveling in the opposite direction than the applied signal. The Signal Direction feature identifies which direction the signal is flowing and hence the target line.

To use the signal direction system:

- Connect the SD mode enabled transmitter to the target pipe in the usual way.

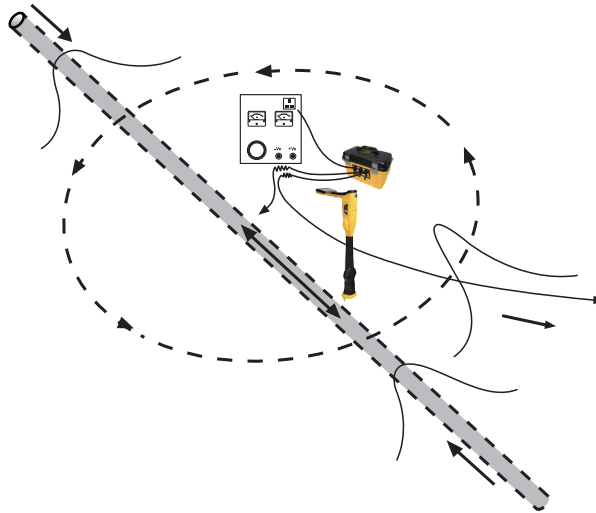

Turn the transmitter and receiver on and set both to:

- o SD-USA – if in North America or any territory where the power system is 60Hz.
- o SD-EUR – if in Europe or any territory where the power system is 50Hz.

Locate the pipe. The receiver may or may not be flashing the “SD” Forward/Back arrows icon.

The arrows appear differently depending on what locate screen is used but follow the convention of green for forward and red for backward. This section of the manual assumes a conventional screen is used, but for reference, the other screens show the arrow as below:

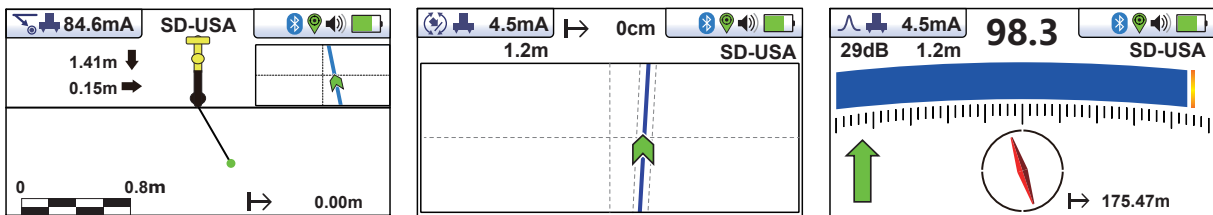

Synchronizing the system

A flashing SD arrow indicates that the unit needs to be synchronized with the transmitter. Even if the arrow is not flashing, it is always good practice to synchronize the system at the beginning of a survey to ensure reliable results and maximize the next synchronization point's distance.

To synchronize the receiver to the transmitter at the beginning of a survey, pinpoint the pipe very close to the transmitter, be sure that it is the correct line. Then, standing facing away from where the transmitter is attached, press the “i” pushbutton. The unit will display the information screen showing the depth of line, signal current, and an “SD” icon positioned over the return pushbutton.

4 Using the vLoc3-DM Receiver

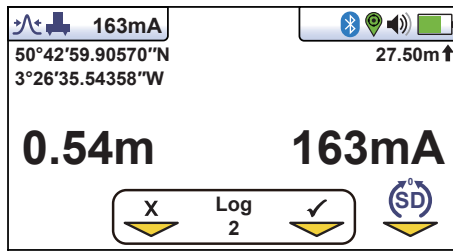

A short press of the Return pushbutton will synchronize the system and return it to the locating screen. The green forward arrow will light and not be flashing, indicating the receiver is locked onto the signal. The system is now synchronized.

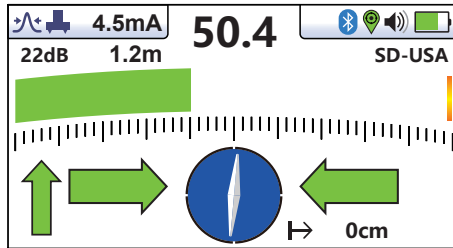

Proceed to locate, trace and pinpoint as required ensuring at all times the green forward arrow is illuminated. If the red backward arrow illuminates at any time this indicates that the wrong line is being located.

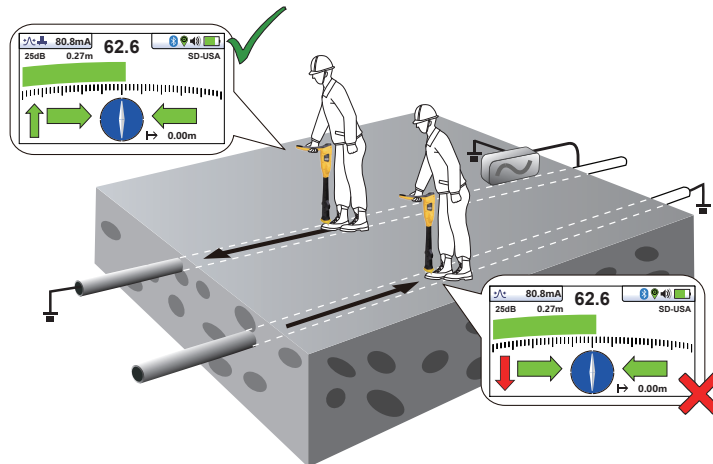

At some point you may find that the SD arrow starts to flash. The flashing SD arrow indicates that synchronization with the transmitter has deteriorated and a reset is required.

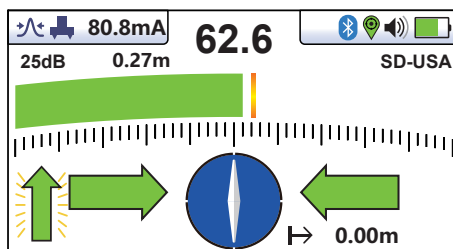

Re-trace your line back to a point where a solid signal direction is obtained. Precisely pinpoint the line and stand with your back to the direction of the transmitter as you did when you initiated the initial sync and press the "I" pushbutton, then a short press of the "Return" pushbutton to re-sync with the transmitter signal.

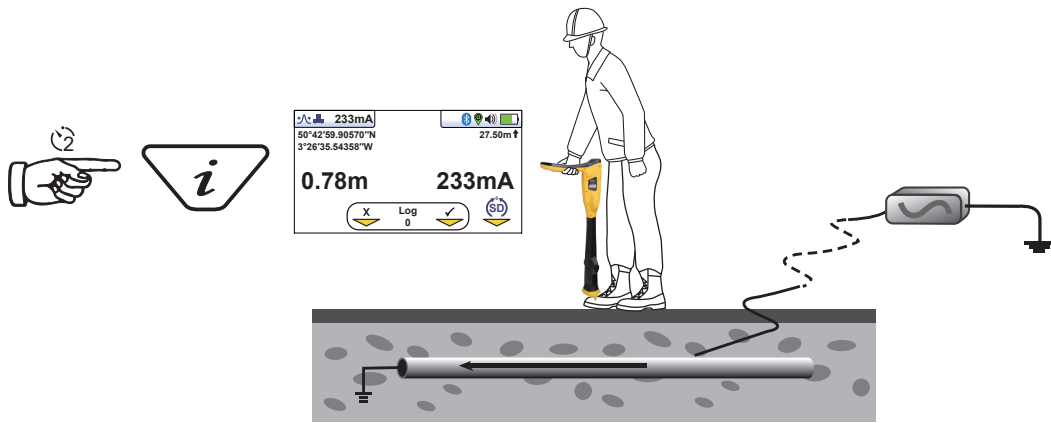

Continue to locate, pinpoint, and trace.

4.11 Using the A-frame Fault Finder

The A-frame is used to pinpoint coating defects along the pipeline. It does this by measuring the voltage in the ground caused by the vLoc3-DM signal current entering the pipe at a fault. It is necessary to make physical/electrical contact with the ground. The A-frame has two spikes to facilitate this. Although the spikes are a few inches long it is usually only necessary to puncture the ground with the spikes. Fully inserting them is only necessary where the ground conditions are particularly dry or high resistance.

The A-frame should be plugged into the accessory port. The receiver will automatically recognize the A-frame and enter the fault find mode. The display will be similar to the one below:

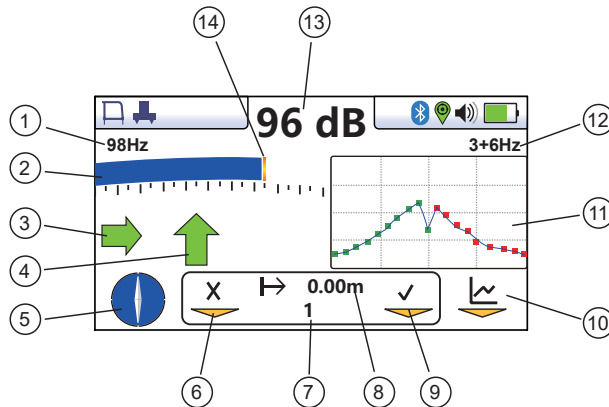

1	Locate frequency	8	Distance from last saved DM current reading
2	Locate signal strength indicator	9	Record data point key
3	Left/Right cable location indicator	10	Graphing options soft key
4	Fault direction indicator	11	Graphing area
5	Compass line direction indicator	12	DM FF frequency
6	Press to delete log	13	Fault find signal level
7	Log number	14	Peak signal level indicator

4 Using the vLoc3-DM Receiver

The A-Frame can be used in two configurations:

Standard Mode (with the low-frequency sensor foot on): This is used to pinpoint or survey a pipeline section by undertaking an ACVG survey (Alternating Current Voltage Gradient). The ACVG and Current gradient survey can be gathered at the same time. See further explanation in the following section.

Simultaneous/Standard mode can be selected in the User Menu.

Simultaneous mode (with the low-frequency sensor foot on): As standard mode with the addition of DM current measurements and ACVG measurements are shown and logged simultaneously. See further explanation in the following section.

Simultaneous/Standard mode can be selected in the User Menu.

4.11.1 Fault Finding Method

Connect the transmitter as previously described. Select either 3Hz/6Hz/98Hz (ELF1) or 3Hz/6Hz/128Hz (ELF2) depending on the mains frequency as previously described.

Using the A-frame

If the approximate position of a defect has been identified by the vLoc3-DM using the current gradient technique, start an A-frame survey approximately 20 meters before this point. Place the A-frame on the ground so that the spikes puncture the ground, and with the A-frame in line and over the pipe the green spike pointing toward the suspected fault.

Use the locate section of the screen to position the A-frame above the pipe.

The signal strength will be displayed and if the signal is strong enough an arrow will point forward. Press the "+" pushbutton to save the reading. This will enter the result into the graph. The scaling of the graph is automated and may change as points are added. Only the last 20 records will be shown on the screen. If you need to review other points press the Enter key, which will take you to the review screen where all points can be reviewed.

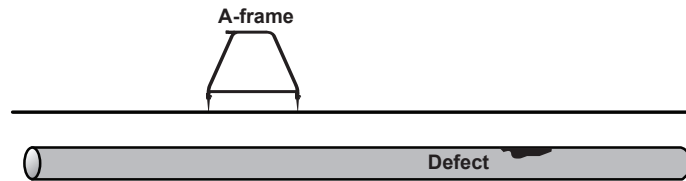

Note that the receiver is not shown to simplify the diagrams. In all diagrams, the vLoc3-DM receiver would be connected.

Continue walking in the arrow direction placing the A-frame in the ground at approximately one-meter intervals saving the results as you go. The graph will rise as the defect is approached and then fall at the defect. Continuing past the defect will create a similar but reversed effect. A typical defect signature is shown below.

Note that the graph's points will change depending on the fault direction indicated, i.e., green for forward and red for backward.

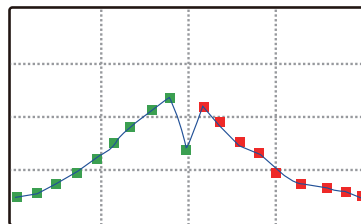

If GPS is not activated the horizontal intervals are assumed to be equal. If a GPS option is activated the intervals are still shown equally on the graph, but the internal data log stores the GPS coordinates with the GPS data. This is because the GPS function's accuracy tends to be less accurate than required for A-frame fault finding.

To delete the log proceed as previously described in "Deleting the log."

4 Using the vLoc3-DM Receiver

At the null point the arrows will reverse, this is the location of the defect. Repeating the procedure across the pipeline will help pinpoint the defect in the other plane. See the following diagram.

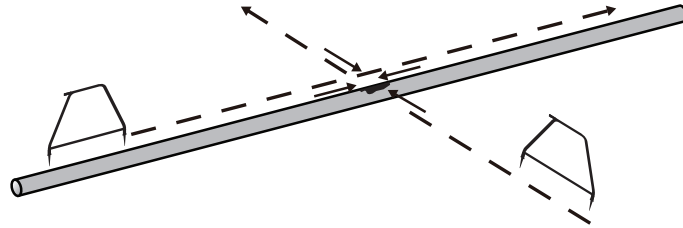

Sometimes it is not possible to gain access to the pipe position. If this is the case walking along the pipe route a few meters to one side can very often produce good results. This procedure is also useful where the pipe runs under blacktop which acts as an insulator preventing the A-frame from making a good connection to the ground.

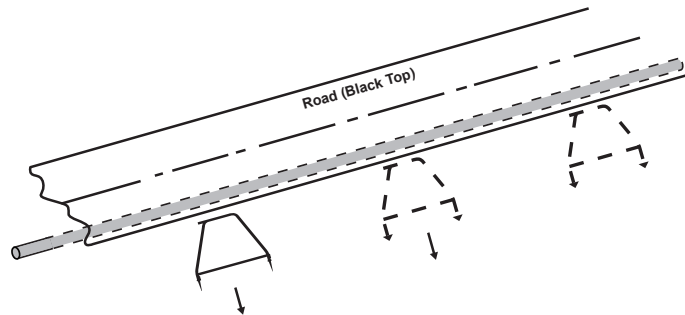

4.11.2 Using the A-frame where there are Many Defects Such as Porous Coating

Poorly coated pipelines such as old bitumen coating may create a confusing result when multiple defects interfere with each other. To overcome this it is sometimes beneficial to adopt a different approach.

This alternative approach involves using the A-frame perpendicular and to one side of the pipeline. See the diagram below:

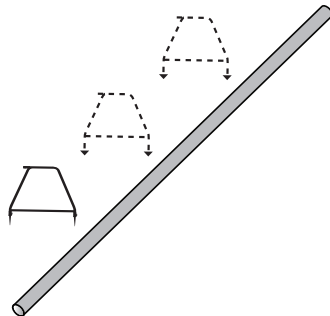

Note the depth of the pipeline. Move approximately this distance to one side. Keep the orientation as the above walk along the section of the pipeline taking readings at regular intervals. A typical result is shown below with the main defect being the largest reading. Note that the arrow will always point to the pipe, i.e., it will not reverse unless the signal reduces to a level that cannot be processed correctly.

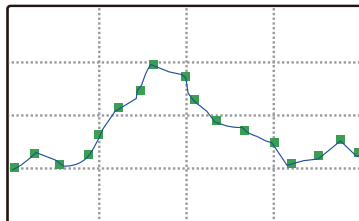

Taking DM current readings when using the A-Frame.

With both the A-Frame and Low-frequency foot fitted it is possible to take DM current readings while remaining in the A-frame mode. This allows the operator to undertake ACVG and current gradient (CAT surveys) at the same time.

To set the unit to Simultaneous mode, enter the User setup Menu and set option "DM Simultaneous Mode" to "Enabled".

Two methods are available and both enable simultaneous ACVG and current gradient mapping.

To take a DM current reading when in the A-Frame mode, press the "Info" key. If in simultaneous mode the following will be displayed:

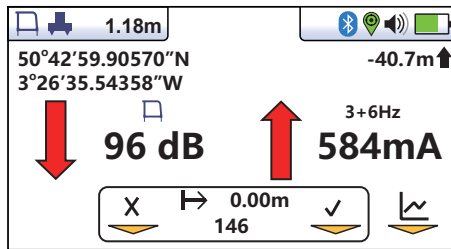

Pressing the Enter key will save both A-frame and DM current readings.

If in **standard mode** the display below will be displayed:

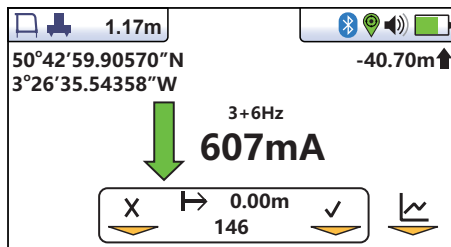

Pressing the Enter key will save the DM current shown with the saved A-Frame results.

In both cases pressing the "Info" key will return the display to the A-Frame screen.

5. Loc3 25-Watt Transmitter Functions and Operation

This section of the manual covers the 25-Watt Loc3-25Tx transmitter.

5.1 The Loc3, 25-Watt Transmitter Overview

The 25-watt transmitter is a rugged portable transmitter powered by a Li-ion rechargeable battery.



1	Loc3-25Tx Transmitter
2	Li-ion battery tray
3	Carry bag
4	AC/DC Adapter, Loc3-25Tx
5	Direct connection lead, Loc3-25Tx
6	Ground stake
7	Mini-USB lead

5.2 Display

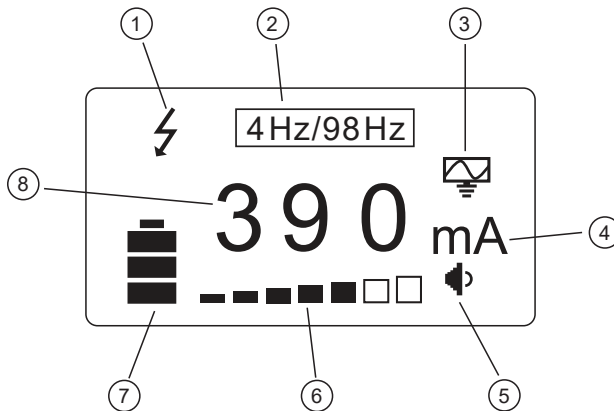

1	High Voltage Warning*
2	Active frequency
3	Mode indication icon
4	Units (mA, volts, ohms)
5	Speaker level
6	Output step bar graph
7	Battery level or DC Input icon
8	Digital readout (mA, volts, ohms)

*Output Protect Warning

The transmitter checks the line when connected. Output protected against accidental momentary connection to up to 230V AC (RMS) will display the “high voltage” warning icon and not allow the transmitter to operate. In addition, the transmitter is protected by a 4A/250V fuse in the event of excessive voltage or voltage spikes on the line.

5.3 Pushbuttons

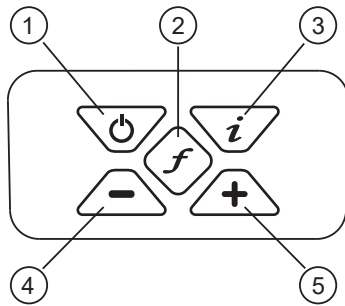

1	On/Off control
2	Frequency selector
3	Information (Volume, Volts, Ohms, Multi-frequencies LCD Contrast, Receiver Link, Frequency menu and About screen)
4	Output decrease/Navigate through the menu
5	Output increase/Navigate through the menu

Transmitter Information Pushbuttons

Press the <i>i</i> button to access the transmitter settings and menu.	
Use the + and - buttons to navigate the settings and menus.	
Use the <i>f</i> button to make selections. An X will appear for selected items.	

25-Watt Transmitter Menu Structure

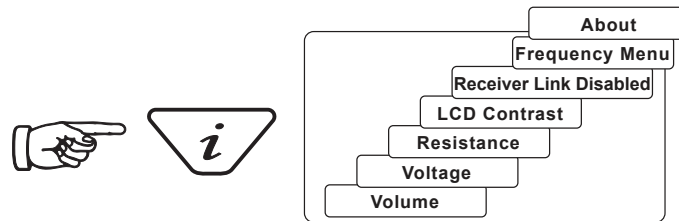

When the “i” (information) pushbutton is pressed, the display will show the volume level. Use the + and - pushbuttons to increase, reduce or turn the speaker off. (off-low-medium-high).

Keep pressing the “i” (information) pushbutton, and the display can be toggled to show “voltage,” “resistance,” or other functions, as shown in the drawing above. The display indicates mA as the default and volts or ohms when selected.



The number of “i” button presses and available sub-menus will vary with the transmitter's mode.

5.4 The Transmitter Connection Block

25-Watt Connection Block

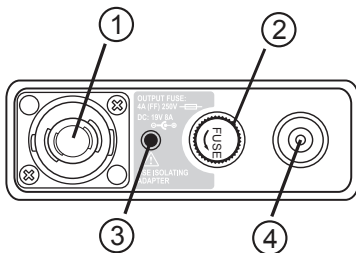

1	Output connection, speakON®
2	Fuse holder - Output protection (4A/250V Fuse)
3	Speaker
4	Battery charging & DC input socket

5 Loc3 25-Watt Transmitter Functions and Operation

All connections to the transmitter are made through the connection block.

The connection block consists of:

- Output socket - For the direct connection lead or transmitter signal clamp.
- Fuse - Protects the transmitter from receiving up to 250V from the target line.
- Speaker - Positioned behind the small hole.
- Charging socket - To charge rechargeable battery tray.

5.5 Transmitter Batteries

The 25-watt transmitter ships with a custom Li-ion battery tray with a charger and power cable.

An optional 12 X D Cell Alkaline battery tray can be used with the 25-watt transmitter, but the output will be limited to 10-watts.

The battery status is shown on the transmitter's LCD. The letters "LP" will appear when the battery status reaches only one bar. At this battery level the max output current and power are limited.

The LED on the charger will show a red light indicating that the charge cycle is in progress. When the batteries are fully charged the LED will change to green.

Follow instructions detailed in the General Safety & Care Information section of this document. Dispose of batteries following your company's practice and environmental standards, the prevailing laws, or recognized best practice. Always dispose of batteries responsibly.



The 25-watt transmitter ships with the Li-ion battery tray. An optional alkaline tray can be used with the 25-watt transmitter, but the power output will be limited to 10-watts.



WARNING

Use only Vivax-Metrotech recommended charger.

Do not attempt to replace the rechargeable batteries or remove battery covers.

Return to Vivax-Metrotech or a Vivax-Metrotech approved service center for replacement.

5.6 Charging the Transmitter Battery Tray

The rechargeable battery tray can be charged while attached to the transmitter or on its own. The battery status or condition is shown on the transmitter's display.

1. Connect the charger to the charging socket on the transmitter's side or directly into the battery tray's charging socket.
2. The LED on the charger will glow red while charging and turn green when fully charged.

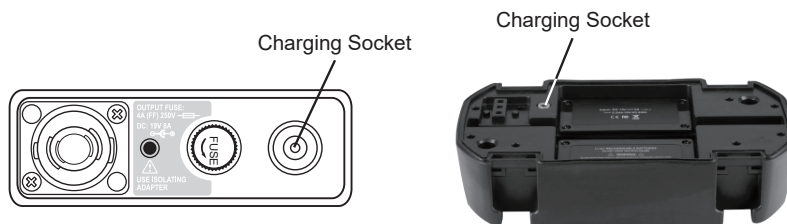

Plug the charger into the charging socket on the side of the transmitter or directly into the battery tray

Battery Charger - Is supplied with the 25-watt transmitter.



Optional 12-volt DC Power Lead - This 30ft/90m lead can be used to power the 25-watt transmitter when connected to a target line at high output levels for extended periods. It will not charge the transmitter battery.



WARNING

Only use a charger supplied by Vivax-Metrotech Corp. Using non-approved chargers may result in damage to the equipment or overheating/explosion.



The rechargeable tray cannot be charged from a 12V DC source.

Follow instructions detailed in the General Safety & Care Information section of this manual. Only use the battery charger supplied as using an unapproved charger may damage the battery pack and may cause overheating.

5.7 Removing and Installing the Battery Tray

These procedures apply to both the Alkaline or Rechargeable battery tray.

Removing the 25-watt transmitter battery tray



1. Reach under the catch and pull to unlock.



2. Lift up the catch and repeat for all four catches.



3. Lift the transmitter base from the battery tray.

Installing the battery tray



The battery tray and transmitter base have a matching aligning post, contact pins and socket.



1. Align the aligning post and lower the transmitter base into the battery tray.



2. Press down on the locking catch until it locks in place. Repeat and lock all four latches.

Aligning the post in their receptacles will assure that the contact pin will mate and not be damaged.

5.8 Transmitter Modes



WARNING

Always connect the transmitter to the target line following your company's procedures. These operations should only be performed by authorized personnel. Always make connections before switching on the unit. Turn the transmitter off before disconnecting.



When the 25-watt transmitter is powered on without connection leads a "NO CONNECTION" message will appear on the LCD. Power off the transmitter and insert the connection leads, and proceed with power up.

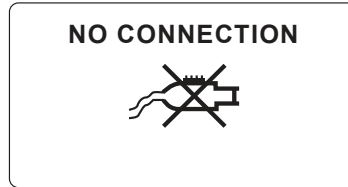

25-Watt Transmitter (Only)

5.8.1 Direct Connection Mode

The **Direct Connection** mode is automatically selected by plugging a connection lead into the output socket. An icon confirming the direct connection mode is shown on the display. The wave in the icon fluctuates when the transmitter is operating. The direct connection lead consists of two colored cables with clips and covers. The red clip must be connected to the conductor being located, the black clip to a suitable ground such as the ground stake provided with the transmitter.

A good connection is indicated by a change in the beep rate from the speaker and the current reading on the display.

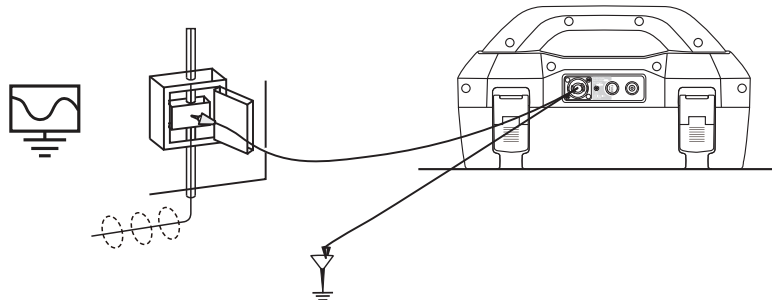

Wherever a direct connection can be safely made without the risk of injury, damage to the customer's plant, or the transmitter, it is the best way of applying the transmitter's signal.

The positioning of the ground connection can also influence the degree of coupling experienced. Ground connections generally should not be made to other pipes or cables or above ground metallic structures such as wire fences. In general, the lower the frequency is, the further the signal will travel, and the less signal-coupling will occur. The most common frequencies used for direct connection are between 512Hz/640Hz and 8kHz.

Regulations in many countries require that power output is limited above specific frequencies. The Loc3 series 5-watt, 10-watt, and 25-watt transmitters enable frequencies below 45kHz to be transmitted using as much as 5-watts, 10-watts or 25-watt output, depending on your transmitter, but frequencies over 45kHz are restricted to 1-watt. Using direct connection and the higher power at the low frequencies helps significantly in achieving greater location distances. Direct connections should not be made to cables carrying greater than 25V (or as your safety practices allow). The transmitter is protected (250V fuse) from stray currents that may exist on the target line.

5.8.2 Clamp Mode

The transmitter signal clamp is a precise way to apply the locate signal. Clamps are generally used when it is impossible to access the conductor to make a direct connection, but there is access to place the clamp around the cable. Clamps are also used when it is not safe to connect because the target cable is live carrying electricity.

The clamp is a specialized inductive device sometimes known as a toroid or coupler. All clamps are optimized to work at specific frequencies. In most cases, clamps are designed to be used at frequencies generally between 8kHz and 9.82kHz. The transmitter will only allow the selection of a suitable range of frequencies for your clamp.

Plugging a Vivax-Metrotech clamp into the output socket will place the transmitter into the “Clamp” mode. An icon confirming this is shown on the display and will flash when the transmitter is transmitting.

When using the clamp no ground connection is needed.

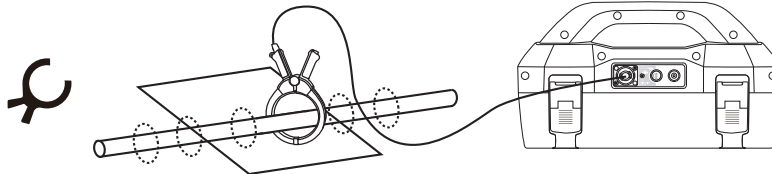

WARNING

When applying the clamp to cables that carry electricity – be sure to follow your company’s safety instructions and procedures. Beware that if applied around a high voltage cable – that cable may induce a current in the clamp, causing it to snap shut or jump quite dramatically. Always apply clamps carefully.

5.8.3 Transmitter Frequencies

The Loc3-25Tx transmitters are supplied with a predefined set of transmitting frequencies. The factory will preset the most commonly used frequencies. Additional frequencies are available to be selected in the frequencies list.

5.8.4 Frequencies and Maximum Power Output

Frequencies power outputs	Loc3-25Tx
Direct connection 25-watt:	32Hz - 9.82kHz

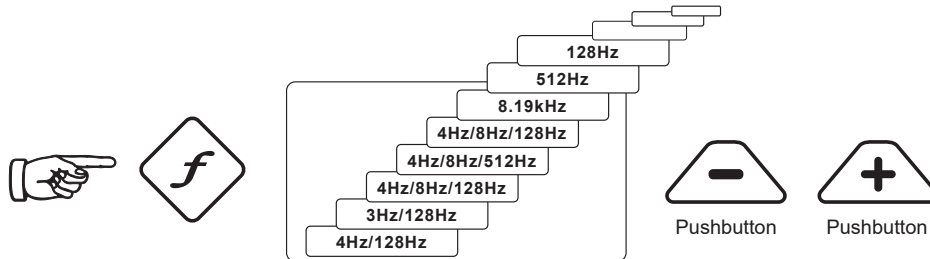

As with most manufacturers, signal clamps are tuned to specific frequencies and **will not** work over the complete range of frequencies.

Frequencies are selected by pressing the “f” pushbutton, which toggles through the frequencies available in the current mode’s available frequencies. The frequency is automatically selected if you don’t toggle past it within two seconds.



The output current is shown in large characters on the display. To increase or reduce the current output, press “+” or “-.” The vertical bar graph at the bottom of the display indicates which of the seven current output steps is being used. If the transmitter can supply the requested current, the bar will turn black. If the bar does not turn black, improving the ground connections or wetting the ground where the earth stake is positioned may help. However, it may not achieve the current setting requested because the line’s impedance is too high for this setting. If this happens, it is best to select a lower setting with a black bar, ensuring a stable output.

The impedance of the target line will limit the current being transmitted; therefore, it is not unusual to increase the output level but see no increase in the currently displayed. This is not a fault with the transmitter.

The transmitter will always revert to first level output when switched on as a power-saving feature. In most circumstances this output level is sufficient. Increasing the output power unnecessarily will reduce battery life. All other settings remain the same as the last setting used.

5.8.5 Most Used Frequencies (Frequency Selection) Feature

This feature allows the operator to choose the most used frequencies from a list of frequencies. Once these frequencies are selected in the main menu, the user can scroll through them by pressing the “f” pushbutton. The user can add or remove frequencies from the above list by following the below procedure. The maximum number of frequencies that can be activated in the most used frequencies list is 12.

The advantage of this feature is the user can work with only their preferred frequencies rather than having a more extensive list of frequencies to scroll through.

Enter the Frequency Menu:

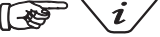
-  Press the “i” pushbutton four to six times (based on the mode that the transmitter is in) until reaching the “Frequency menu” sub-menu.

In Direct Connection mode

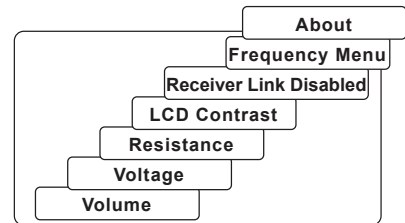

In SD mode

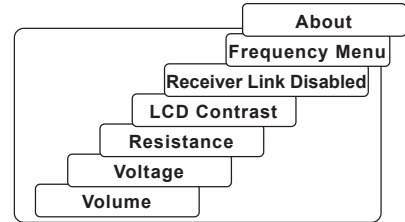

In Clamp mode

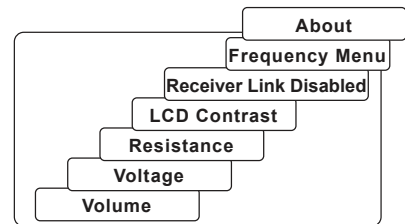

- The screen will show a list of frequencies available with the central one in a box.

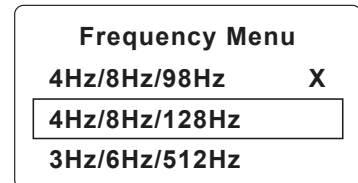

- Pressing the “+” or “-” pushbuttons you can scroll up or down through the available frequencies.

- Once the wanted frequency is inside the box press the “f” pushbutton to select or deselect the frequency. An “x” will appear in the box for a selected frequency.

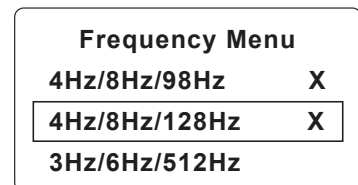

5 Loc3 25-Watt Transmitter Functions and Operation

- After selecting the frequencies press the “i” pushbutton again to exit the “Frequency Menu” and return to the main display.
- A particular frequency in the chosen list of frequencies can be selected from the screen by pressing the “f” pushbutton until the wanted frequency is displayed at the top of the main screen.

5.8.6 Multi-Frequency Mode for Direct Connection

This feature can be used to energize two or three frequencies simultaneously on the target line. This is especially helpful when the user is unsure which frequency is best to apply to the target line.



- When using the multi-frequency mode total power will be split between the activated frequencies.
- The multi-frequency mode is not available in Fault Find and SD modes.
- The frequencies have to be available in the main menu.

Enter the Multi-frequency Setup menu:

- Press the “i” pushbutton seven times to get to the “Multi-Frequency” screen and press the “f” pushbutton to activate the multi-frequency mode. An “x” symbol will appear indicating that the multi-frequency mode is activated. Press the “f” pushbutton again to go to the “Multi-Frequency. Setup” screen to choose the frequencies.

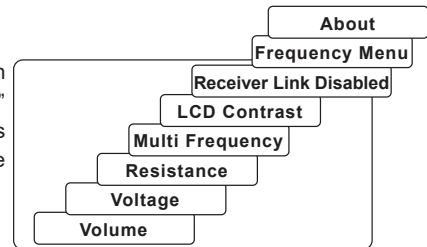

- Use the “+” and “-” pushbuttons to scroll through the available frequencies and add the desired frequency in the first box

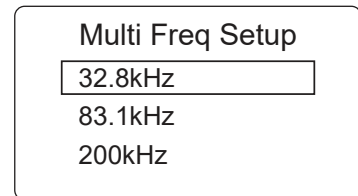

- Press the “f” pushbutton to move the box down and the “+” and “-” pushbuttons to select the second frequency.

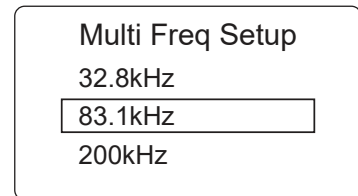

- Repeat step three to select the third frequency if needed.

- Press the “i” pushbutton to return to the main display. On the main display, “Multi” will appear, indicating the multi-frequency mode is active.

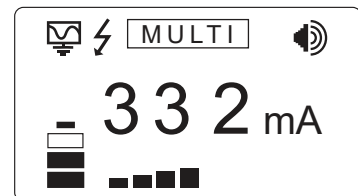

- The frequencies selected for multi-frequency mode will be saved until changes are made even when the multi-frequency mode is deactivated.

6. Loc-150Tx (150-Watt) Transmitter Functions and Operations

6.1 Transmitter Overview

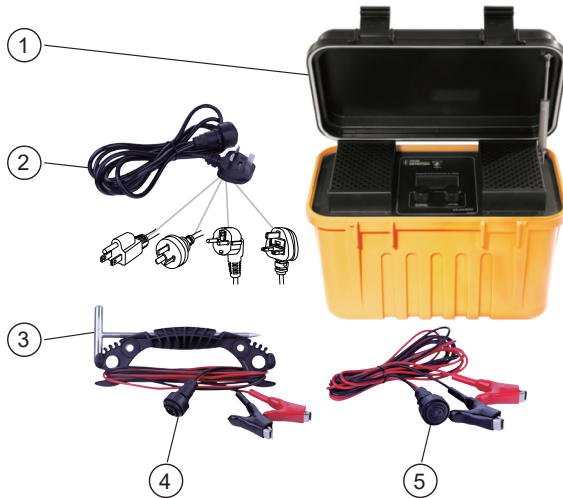

1	Loc-150Tx Transmitter
2	AC power cord
3	Ground stake
4	Signal Output Cable
5	DC power cord

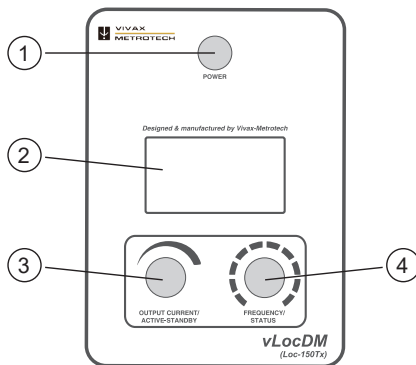

Ref.	Control	Function
1	Power	To power on/off the unit
2	LCD Display	View menu status and information from the transmitter
3	Output Current/Active-Standby	<ul style="list-style-type: none"> - Rotate rotary switch to select output current - Press and hold to power on or standby
4	Frequency/Status	<ul style="list-style-type: none"> - Rotate rotary switch to select a frequency - Press momentarily to view status (refer to status screen in the section below)

6.2 Display

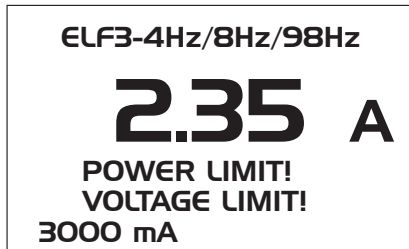

Main Screen

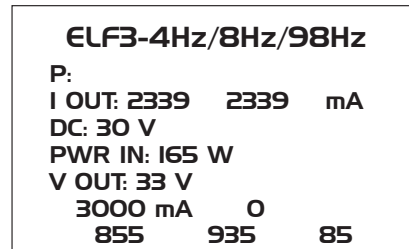

Status Screen



Power Limit = The Overpower alarm will be shown on the display when the transmitter's output power rating is reached (150W or 50W if 12-28Vdc input is used).

Voltage Limit = The output voltage limit is 100V. If the current cannot be stabilized with a voltage less than 100V it will display an overvoltage alarm.

6.3 Power Supplies and Connections



1	Mains Input
2	Mains Input Fuse (5A, 250V)
3	12 - 60V DC Input
4	Output Fuse (10A, 250V)
5	Output Socket

6.4 Connecting to a Pipeline

6.4.1 Connecting at a CP (Cathodic Protection) Station



WARNING

Connecting to the CP station involves removing connections from the CP transformer rectifier and should only be performed by authorized personnel. Always make connections before switching on the unit. Switch off before disconnecting the transmitter.

Method:

1. Make a note of the CP settings (output current and voltage settings). It is crucial as the settings must be checked to ensure they return to the original settings when the connections are re-made.

6 Loc-150Tx (150-Watt) Transmitter Functions and Operations

- Switch off the CP transformer rectifier and allow the residual voltage to dissipate. It may be a few seconds or a few minutes depending on the pipe condition.

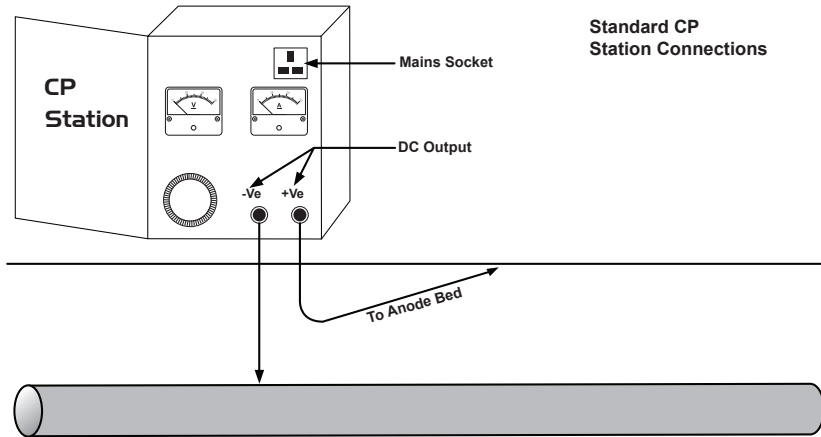

- Disconnect the output wires connecting the CP station to the pipeline and anode bed. If there is an earthed mains socket at the station connect the transmitter mains power lead to the socket.

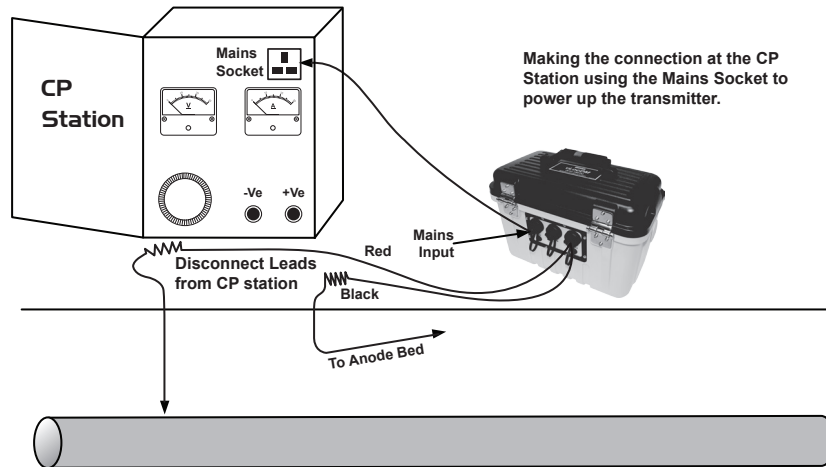

- If there is no main socket it is possible to use the transformer rectifier's DC output. See the diagram below.

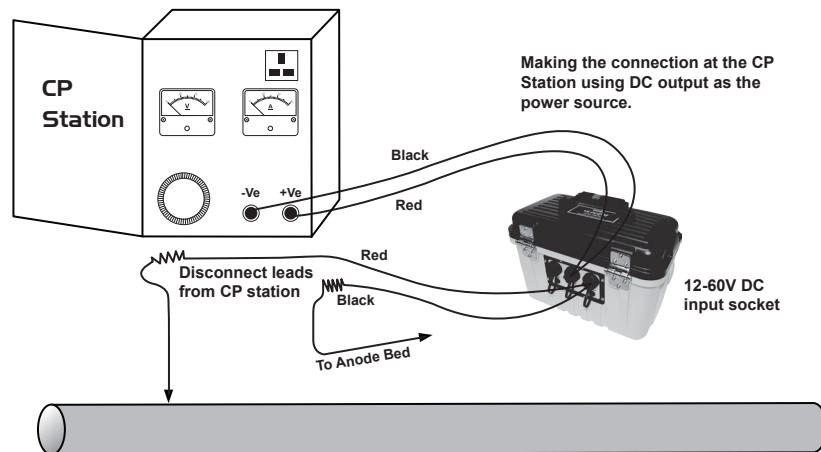

- Adjust the transformer output to approximately 40V DC (although the unit will function from 12V DC to 60V DC) and use the DC input lead to connect the transmitter to the transformer terminals.

- The output lead connected to the transmitter connects the red wire to the lead connecting to the pipeline. Connect the Black wire to the lead connecting to the anode bed. See the diagram above.



If the output leads are white and green, the white cable should be connected to the pipe.

6.4.2 Connecting to the Pipe when there is No Access to a CP Station

Sacrificial Anode

Very often the cable connecting a sacrificial anode to a pipe is fed through an above-ground connection box. In this case, the anode can be disconnected, and these cables used to connect the transmitter to the pipe. The Red connection lead needs to be connected to the pipe side and the black to the sacrificial anode.

It will be necessary to power the transmitter either from a portable 110V AC mains generator or from a vehicle car battery or external 12V DC power source.



It may not be possible to attain high current from the transmitter, as a sacrificial anode will not provide as good a ground as a system anode bed.

Connecting at a Point where Access to the Pipe is Possible

It is possible to connect the transmitter at any point along the pipe length where an electrical connection is possible. If this is the case, a good independent ground will need to be generated by driving a ground stake into the ground a few meters perpendicular to the pipe. The ground needs to be low impedance so the copper ground rod needs to be at least 0.5 meters long. In some cases multiple stakes may be necessary.

A poor ground will result in the transmitter showing the overvoltage alarm even at low currents. If this occurs add more ground rods connected in parallel and dampen the surrounding soil.



WARNING

Use a cable locator to ensure the area is clear of services before the rod is driven into the ground.

6.5 Selecting the Correct Frequency

The available frequency options are:

- 98Hz
- 128Hz
- 512Hz
- 640Hz
- ELF1-3Hz/6Hz/98Hz
- ELF2-3Hz/6Hz/128Hz
- ELF3-4Hz/8Hz/98Hz
- ELF4-4Hz/8Hz/128Hz
- SD EUR (640/320Hz)
- SD USA (512/256Hz)

Note that some frequencies may be missing depending on the age and software revision of the transmitter. Vivax-Metrotech reserves the right to change the frequency list without notification.

3Hz/6Hz/98Hz or 3Hz/6Hz/128Hz is the most commonly used frequencies. They provide the low-frequency 3Hz component required for current mapping and a low frequency (98Hz or 128Hz depending on local mains frequencies) used to pinpoint the position and is used to determine the pipe depth. The 6Hz or 8Hz enables the locator to calculate the DM current direction.

The other frequency options can be used to improve reception in areas of high interference.

SD signals are explained in the section: Signal Direction Precision Identification

6.6 Output Current Select

There are seven current settings:

- 100mA
- 300mA
- 600mA
- 1A
- 2A
- 3A
- 4A (when a single locate frequency is selected)

Choosing the correct setting for a particular application depends on many factors. As a general rule the higher settings are better. The higher the current the more stable the readings at long distances and larger currents create more considerable current changes at faults. However, it will not always be possible or desirable to apply the maximum current.

With the transmitter connected as described above, select the 3A position. Wait to see if any alarms are displayed, such as over-voltage, overpower, over-temperature. If after 20 seconds no alarms are shown note the return current reading. It should be 3A +/- 0.1A. Now note the output voltage. It should be less than 100V. The transmitter stabilizes the output current by altering the output voltage. The output voltage limit is 100V. If the current cannot be stabilized with a voltage less than 100V it will display an overvoltage alarm. The transmitter is not damaged if this is displayed but the output will not be stabilized. To overcome this select a lower current setting.

Other causes of overvoltage alarms are:

1. Pipeline in very good condition (small high impedance faults will require higher voltages to achieve the requested current).
2. Poor anode bed -Poor anode beds will require a high voltage drop across them to create the requested current.
3. Poor pipe connections.

6.7 Alarms

6.7.1 Over Voltage

Output exceeds 100V. (also see Output Current Select)

6.7.2 Over Temperature

The over-temperature alarm will show on the display when the temperature of the output amplifier exceeds a predetermined level. The unit will shut down at this temperature and cannot be switched on until the unit has cooled down.

After the unit has been cooled down it may be necessary to place the unit in a position where the ambient temperature is less, such as a shaded position. Alternatively, select a lower current output.

6.7.3 Overpower

The Over Power alarm will be shown on the display when the transmitter's output power rating is reached. The unit will shut down until the output power is reduced.

This can be doing either:

1. Reduce the output current setting.
2. Improve the ground and pipe connections. This may be the case where the ground used is not an anode bed. For instance, where a ground rod is used because access to a CP station is not possible.

7. Using External GPS

7.1 Compatible GPS and GPS Data Loggers

The vLoc3-DM is compatible with most Bluetooth operating systems.

7.2 Bluetooth



The vLoc3-DM receiver can be fitted with an optional Bluetooth communications accessory. Doing so allows communication with external GPS and or Dataloggers. The Bluetooth option can be retrofitted and can be ordered at a later date if preferred.

7.2.1 Fitting the Bluetooth Module

1. Turn the receiver off and remove the battery pack.
2. With a small cross-head screwdriver remove the two screws of the module cover and remove the cover.



Remove screws



Remove cover

3. The slot on the left is for the Bluetooth module, the slot on the right is not active and for future developments. Carefully slide the Bluetooth module into the slot and press with your thumb to secure it in the slot.



Install the Bluetooth module into the left slot

4. Replace the cover and tighten the two retaining screws being careful not to overtighten.
5. Install the receiver battery, switch on the unit and after a few seconds a black Bluetooth icon should appear showing that the module is fitted.
6. If the Bluetooth icon is grey this means the GPS option is not fitted or incorrectly fitted.
7. The Bluetooth can communicate with external devices that are also Bluetooth enabled. Generally, Bluetooth devices fall into two categories, high or low power devices. vLoc3-DM Bluetooth is compatible with low-power devices.

7.3 Pairing with external GPS/Dataloggers

To pair with an external device first ensure the Bluetooth option is fitted. Check on the Status bar on the display. If the Bluetooth icon is grey this means it is not fitted. A black icon indicates the option is fitted. The Bluetooth is retrofittable and is "Plug and Play."

Method

- Switch on the external device.
- Switch on the vLoc3-DM and enter the User setup menu by a long press on the "i" button.
- Use the "+" and "-" keys to scroll down to the option "Bluetooth Pairing."
- Press the Enter key.
- Press the Enter key to commence "Bluetooth search."
- A list of available devices will be shown.
- Scroll down to the desired device and press the Enter key.
- Double press the "i" button to return to the main screen.
- After a few seconds the Bluetooth icon should turn blue indicating the device has paired successfully.
- The unit will remember the pairing even after switching off. However, the unit can only remember one unit at a time so if the unit is paired with another device the settings will be forgotten.

7 Using External GPS

GPS (Global Positioning System)/GNSS (Global Navigation Satellite System)

The vLoc3-DM can utilize location data from an external GPS/GNSS. The vLoc3-DM will need to be paired with an external device (see the previous section on Bluetooth devices).

Once paired with an external device the vLoc3-DM will await valid GPS data from the external device. The GPS icon will turn green when a valid GPS signal is detected. The change can take from a few seconds to a few minutes depending on the device and whether it is doing a cold or hot start.



8. Transferring Data from the Locator

This section of the manual covers using the MyLocator3 App with the vLoc3 series of receivers. The vLoc3 receiver will need to be connected to the computer running the MyLocator3 program. Connect your vLoc3 receiver to your computer via the supplied mini-USB cable. The mini-USB port can be found under the battery cover flap of the vLoc3 series receivers.



8.1 MyLocator3 Overview

MyLocator3 is a desktop PC application to update the firmware and download field data from the vLoc3 series receivers.

Data transfer - Download the data collected from the locator, including a timestamp, GPS coordinates, depth measurements, current on the line, and notes entered while locating.

Firmware and Software updates – MyLocator3 checks for firmware updates for the receivers and software updates for the MyLocator3 app whenever it is connected to the internet.

Personalize – Add owner/user information, a background picture or logo, or a short message to the startup screen.

Lock Feature – The locator’s configurations and settings can be locked, enabling equipment or safety officers to ensure that users cannot override features selected or removed by management (requires optional lockout dongle).

The first part of this manual (Basic Operation) describes usage not requiring a USB security dongle. The second part of this document (Advanced Features) describes usage requiring a security dongle.

8.2 MyLocator3’s Basic Operation

MyLocator3 operation not requiring a USB security dongle.

8.2.1 Updates Page

When a locator is first connected to the PC the “Updates Page” will be displayed. The updates page will show the locator variant type, the locator serial number, and the running firmware version in the upper left-hand boxes. The upper right-hand box will show information about the MyLocator3 PC application.

Clicking on the Clock symbol sets the locator time to UTC. To check local and UTC hover over the Icon and the times will be displayed to the right flashing alternately.

MyLocator3 can also be viewed in several language options. Click on the pull-down menu to select the desired option.

Checking the “Auto Load Config” box ensures the locator’s configuration setting is automatically uploaded to the MyLocator3 app when the locator is connected.

8 Transferring Data from the Locator

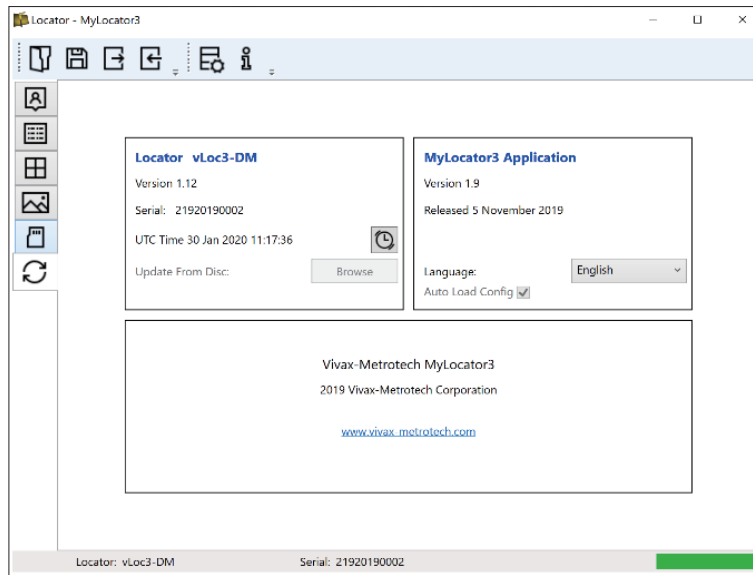

8.2.2 Application Update

Every time the MyLocator3 Application is started its version number is checked against the latest version available on the Vivax-Metrotech server. The user is notified if an update is available as shown below. This feature will only be available if the computer is online.

Clicking on the Update Now button will download the latest version from the Vivax-Metrotech server, which the user can install.

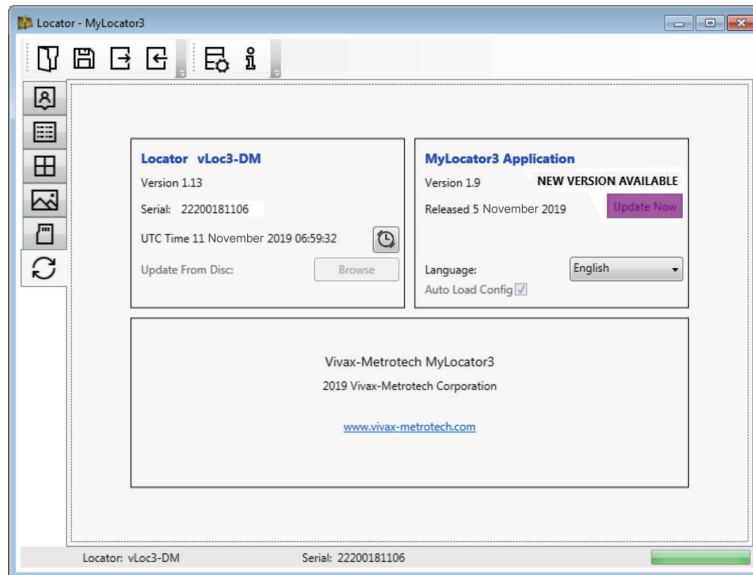

8.2.3 Locator Firmware update

Each time a locator is connected to the PC, its firmware version is checked against the latest version available on the Vivax-Metrotech server and the user is notified if an update is available as shown below. This feature will only be available if the computer is online.

Clicking on the Update Now button will fetch the latest version from the server and then download it to the locator.

The “Update From Disc” feature will only be available if a suitable dongle is also attached to the PC. This feature allows the user to install older versions of firmware stored on the computer, although it is advised that only the latest version of firmware is used.

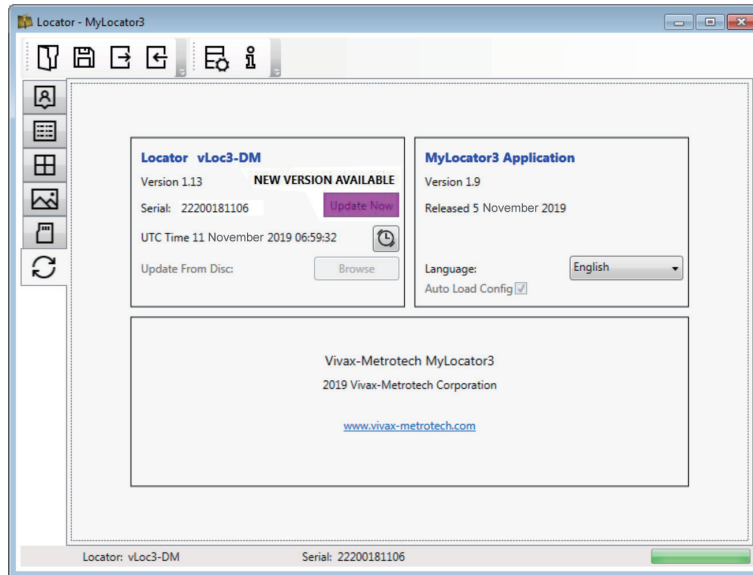

8.2.4 Toolbar

The vLoc3 series receivers can be configured so that features can be switched on or off. Doing this enables the user to tailor the instrument to meet their application's needs while keeping the user interface uncluttered. The toolbar at the top of the screen enables the user to create configurations.

The application toolbar looks like this:



	Opens an existing configuration file (*.vmcfg).		Reads the configuration from the connected locator.
	Saves the configuration to a file.		Displays information about MyLocator3.
	Writes the configuration to the connected locator.		

8.2.5 Data Logging

Clicking on the Data Logging tab will display information about the state of the attached locator's data log contents. The data log contents can be stepped-through by using the controls on the right-hand side. The user can upload a selection of logs from the locator to the PC using the upper right-hand side controls. The data in the data log can be configured before exporting. The parameters that can be set are:

- Distance units
- Date format
- Time format, i.e., UTC or local time

Files may be exported/saved locally as .csv/.bin/.kml/.shp files and examined later. The default filename is based on the serial number of the connected locator but can be changed during the saving process.



If it is only required to export a portion of the log, for instance, a survey on a particular day, use the data log scroll facility at the bottom left of the display to scroll through to the start date/time. Note the log number and then scroll to the end date/time and note this log number. Use these numbers to enter the “From” “To” numbers in the display’s top right when exporting. Doing so will help to keep the exported data to a manageable size.

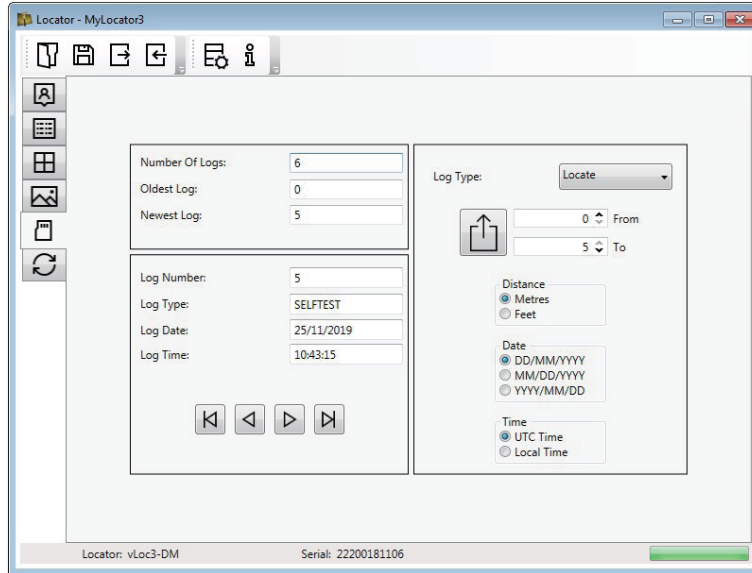

8.2.6 Splash Screen

In this section, an image can be loaded as a splash screen when the locator is turned on. The locator has an LCD screen with a resolution of 480 by 272 pixels. The image loaded into MyLocator3 will be scaled to fit the width of the screen. If the scaled image height is less than the LCD height then the image is centered vertically and white bars are used as padding. If the scaled image height is greater than the LCD height the image can be re-positioned vertically by clicking and dragging the left mouse button anywhere on the image.

To insert your startup screen first click on the “Open” button. Then browse your files to select the picture required as the startup screen. The application is compatible with .jpg, .bmp, .png, and .gif file formats.

The startup screen will be displayed in the application.

The “Download” button can be used to immediately set the splash screen, or the image can be sent to the locator along with the rest of the configuration by pressing the “Write Configuration” button.

To remove a startup screen and revert to the default Vivax-Metrotech screen, click on the “Clear” button and download the cleared screen.

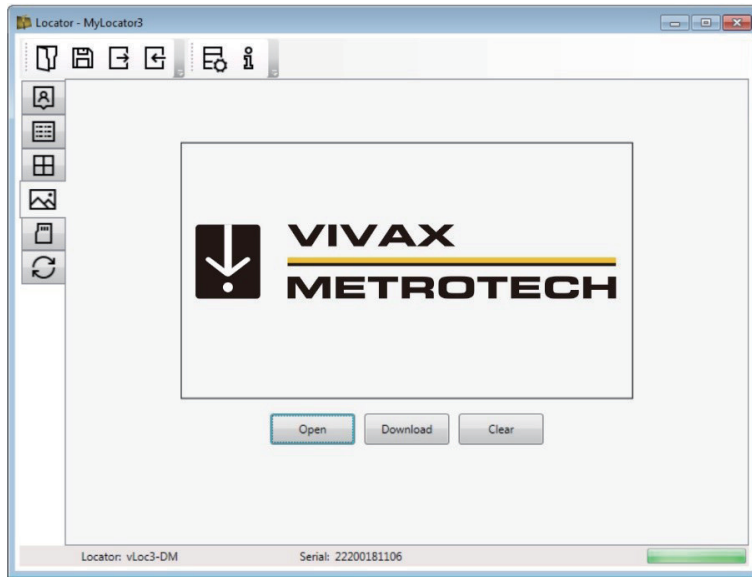

8.2.7 Frequencies Page

The "Frequencies" page will allow the user to refine which frequency modes are available when the locator F-key is pressed and which frequencies appear on the locator menu.

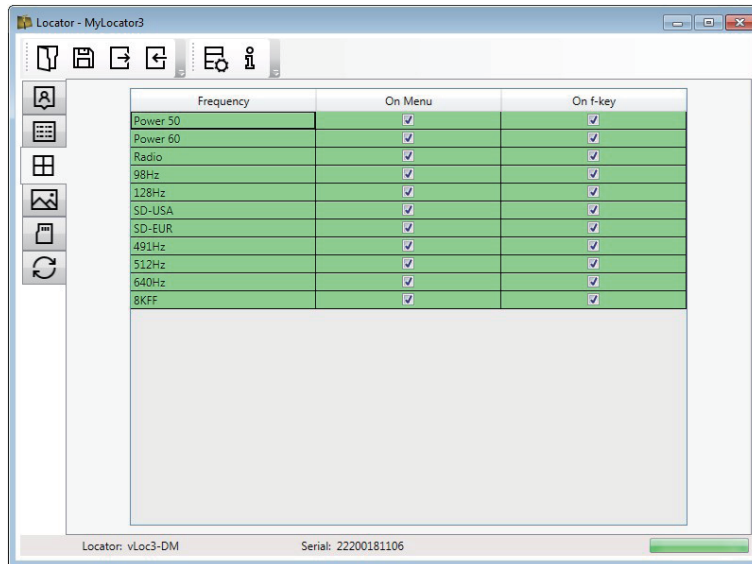

8.2.8 Menu Settings

The “Menu Settings” page allows the user control over which menu items appear on the locator and the menu item's initial setting when the locator is first used after configuration.

The menu items with a right-pointing arrow  can be expanded to reveal additional sub-menu items. If the “On-Menu” item is ticked, then the item will appear on the locator menu. The item displayed in the “Setting” column will be the initial locator setting after configuration. If the “Setting” value is not selected, then the locator setting will be unchanged.

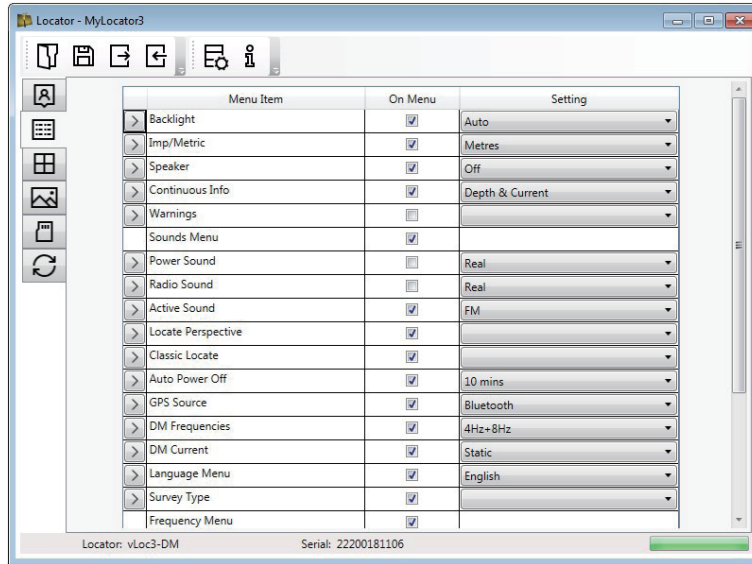

8.3 Advanced Features

The Advanced Features are available to those users in possession of a USB security dongle. If a dongle is attached to the PC, its level will be displayed on the MyLocator3 status bar.

Three levels of security come with the dongle. Level one is for the end-user supervisors, level two for Vivax-Metrotech's distributors, repair centers, managers, and level three for Vivax-Metrotech use only.

8.3.1 Supervisor Lockouts

This feature is available to anyone with a dongle. Contact Vivax-Metrotech to purchase a dongle. When a dongle is connected to your computer via a standard USB socket the icons for the “Splash Screen” page, “Frequencies” page and the “Menu Settings” page will change color to green. This color indicates the page is unlocked.



Levels of Dongle security

1. End-user supervisors
2. Vivax-Metrotech distributors, repair centers, and managers
3. For Vivax-Metrotech, engineers use only

The Splash Screen page, Frequencies page, and Menu Settings page can be individually locked by double-clicking on their page tab icon. If a page is locked a user can only access it with an appropriate security dongle. Doing so will prevent unauthorized users from changing protected locator items. i.e., the “Splash Screen” can be locked to prevent the user from changing it.

The page tab icon will change color from green to amber.

To unlock a tab with the dongle connected double click on the tab to unlock.

9. Interpreting Results

9.1 Introduction

Using the vLoc3-DM system can quickly and efficiently assess the general coating of a pipeline network. It can help identify defects and possible shorts to other structures. It can be used as a tool to prioritize and plan work on the network. However, unless care is taken when interpreting the results misinterpretation can lead to unnecessary work and expenses.

9.2 Sources of Error

Most errors are either caused by carelessness in taking readings or by interference or distorted signal field.

9.2.1 Operator Error

Care must be taken when taking readings. Great care should be taken to pinpoint the position of the pipeline before a measurement is taken. The locator must be aligned and held vertically. The measurements are only as good as the care taken to obtain them.

The sensors used to detect the low-frequency vLoc3-DM profiling signal are very sensitive to low frequencies. Moving the instrument while the unit calculates the information will cause the strong earth's magnetic field to induce an interfering signal into the sensors resulting in errors. The vLoc3-DM must be kept still while it is taking measurements.

9.2.2 Interference (Distorted Fields)

The vLoc3-DM evaluates the electromagnetic field signal radiating from a pipeline to determine the information required. It assumed that the field is uniformly radiating from the pipe. Unfortunately the field is prone to be distorted, and this can lead to errors.

9.2.2.1 Source of Interference (Distorted Fields)

Source of Interference (Distorted Fields)

There are many sources of field distortion, but this handbook lists some of the more common sources of distortion:

- Changes in Pipeline Direction
- Adjacent Pipes or Cables
- Cross Bonding
- Passing Vehicles
- Pipe Sleeving
- Changes in Pipeline Direction

Whenever there is a change in the pipeline direction there will be some field distortion. See the diagram below. The sharper the change the bigger the distortion. Avoid taking measurements at these points.

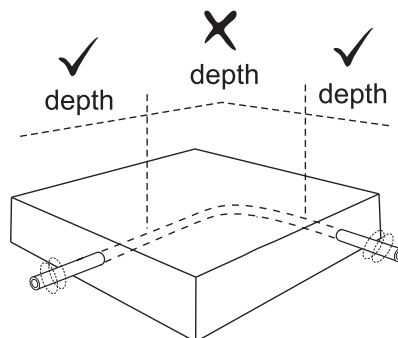

- **Adjacent Pipes or Cables**

Adjacent pipelines or cables very often have a signal induced onto them by capacitance or inductive effects. These signals will interfere with the signal on the target pipe and will cause distortion. See the diagram below.

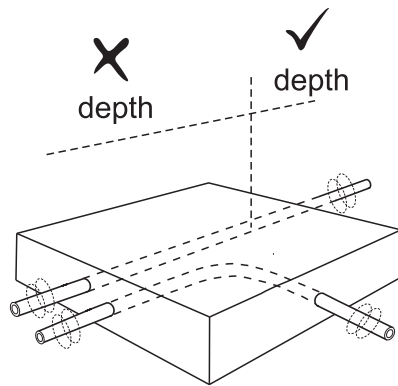

• **Cross Bonding**

Pipes can often be cross bonded. This is deliberate to reduce the number of CP stations and to limit the effects of stray currents.

If the pipes are laid in the same path and are nearby the currents flowing on the two pipes will interfere with each other and cause interference. For best results, the cross bonding should be disconnected for the duration of the survey.

• **Passing Vehicles**

The sensing devices used to detect the 3Hz vLoc3-DM profiling signal are very sensitive to low frequencies. Vehicles passing very close to the receiver will disturb the earth's magnetic field and distort the received signal. Try to take measurements when there is a gap in passing vehicles.

In areas where traffic is passing wait until three constant consecutive readings have been shown before saving results.

• **Pipe Slewing**

It is common practice to insert a pipe in a protective steel sleeve. This may distort the signal and cause errors. Take readings before and after the sleeve. If they are the same the pipeline is well insulated through the sleeve. Sleeves are very often used at road crossings.

9.2.2.2 Checking for Distorted Fields

Check to see if other radiated fields are distorting the signal. Locate the pipe, first in the "Peak" mode and then in the "Null" mode. The two should indicate that the pipe is in the same place. If they do not the signal field is distorted.

If the antenna mode "Peak with arrows" is selected the same can be achieved without switching between modes. To do this, first, find the position of the pipe using the largest bar graph reading as above. Then find the position as indicated by the arrows. The arrows will indicate the same position as the null response of the bar graph. Hence, if the arrows and bar graph indicates the same position there is unlikely to be significant field distortion.

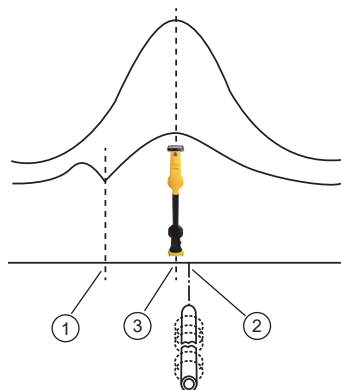

1	Null Position
2	True Position
3	Peak Position

9 Interpreting Results

9.3 Viewing Data

Upload the data from the vLoc3-DM receiver as described previously in section Upload Data Files. Files can be saved in .txt, .kml, or .shp formats.

9.3.1 Viewing .xls Files

Open an Excel spreadsheet and open the desired file. Something similar to the screen below will be displayed. The data is now in the form of an Excel spreadsheet and can be manipulated to create suitable graphs.

Log No	Date	Time (UTC)	Longitude	Latitude	Distance (m)	Accumulated Distance	Depth (m)	Current (A)	Frequency (Hz)	Mode	DM Current (A)	DM Current Direction
0	5/9/9	12:26:41	Ad 53m 15.85s E	51d 48m 8.742s N	0	0	0	0.976	0.046	98 Peak	0.1532	Forwards
1	5/9/9	12:27:54	Ad 53m 15.846s E	51d 48m 9.258s N	17	17	17	0.979	0.047	98 Peak	0.152	Forwards
4	5/9/9	12:28:34	Ad 53m 34.134s E	51d 48m 9.426s N	25	42	42	0.944	0.043	98 Peak	0.1561	Forwards
5	5/9/9	12:29:30	Ad 53m 32.732s E	51d 48m 9.57s N	27	69	69	0.995	0.046	98 Peak	0.1606	Forwards
6	5/9/9	12:30:27	Ad 53m 31.272s E	51d 48m 9.49s N	28	97	97	0.976	0.048	98 Peak	0.1505	Forwards
7	5/9/9	12:31:00	Ad 53m 28.374s E	51d 48m 9.755s N	26	123	123	0.962	0.039	98 Peak	0.1548	Forwards
8	5/9/9	12:33:34	Ad 53m 28.398s E	51d 48m 9.483s N	28	151	151	0.976	0.039	98 Peak	0.1396	Forwards
9	7/5/9	12:34:36	Ad 53m 27.984s E	51d 48m 8.958s N	28	179	179	1.021	0.032	98 Peak	0.1458	Forwards
10	8/5/9	12:35:33	Ad 53m 27.634s E	51d 48m 8.124s N	26	205	205	1.102	0.029	98 Peak	0.1433	Forwards
11	9/5/9	12:36:17	Ad 53m 27.816s E	51d 48m 7.47s N	20	225	225	1.1	0.029	98 Peak	0.1411	Forwards
12	10/5/9	12:41:33	Ad 53m 28.323s E	51d 48m 6.81s N	22	247	247	0.955	0.033	98 Peak	0.1314	Forwards
13	11/5/9	12:42:28	Ad 53m 28.536s E	51d 48m 6.378s N	13	260	260	1.065	0.016	98 Peak	0.0146	Forwards
14	12/5/9	12:51:48	Ad 53m 28.816s E	51d 48m 6.765s N	20	280	280	0.851	0.008	98 Peak	0.0121	Forwards

In the example above, the distance column is populated automatically as the GPS option was used when data were collected. If GPS was not used the distance between measurements would have to be inserted manually.

- It is now possible to generate a graph. Graphs are most commonly done as vLoc3-DM current against distance.
- Highlight the Accumulated Distance records and then press the “Ctrl” key while highlighting the vLoc3-DM Current column.
- From the “Insert” tab select “Scatter Plot.” From the menu select the desired graph. The graph will then be generated as below.

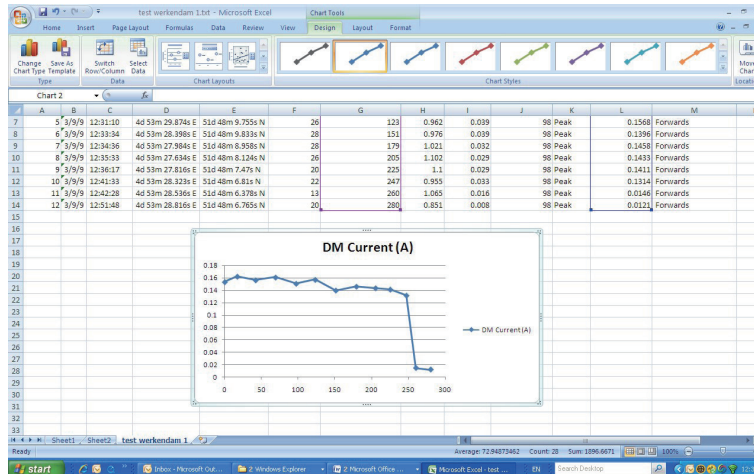

The graph is drawn with a linear current x-axis. If a logarithmic scale is required right-click on the x-axis and select logarithmic from the options below.

9 Interpreting Results

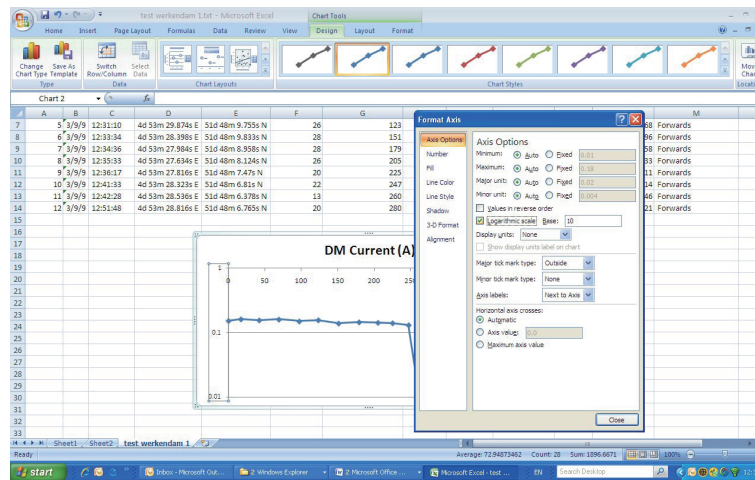

9.3.2 Viewing .kml Files

To view .kml files it is necessary to have Google Earth installed on the host computer. If not already done please visit the Google Earth Web and install the latest version.

To launch a .kml file, double click on the selected file. If connected to the web and if the Google Earth application is installed on the host computer Google Earth will automatically launch and zoom to the site location. Pins will indicate survey points. Clicking on a point will show measurement details for that point. (note these details are continually under review and may change without notice).

The map is a typical representation, but note that this feature is under continual development and may change to include new features without notice.



9.4 Interpreting Graphs

Two types of graphs can be plotted. These can either *Linear* or *Logarithmic*

In both cases it is important to look at the trend of the graph rather than individual points. This is because the signals radiating from a pipe can be affected by many external influences such as:

- passing cars
- ground currents from stray currents
- ground currents from the transmitter
- slight movements of the receiver

These are just a few examples, the list is probably endless.

The intention is to identify changes in current, which signifies a defect. So if we were to look at a small section of the graph it is, incorrectly possible to interpret fluctuations as a defect. See the diagram below.

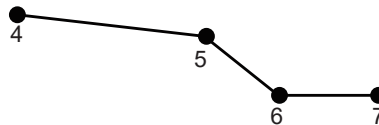

Section Points 4-7 of Graph A

Just taking points 4/5/6/7 is possible to think that there is a defect at this point. However, looking at points 1 to 20 shows that there is in fact a trend of signal loss at points 10-13, which is the more likely fault location.

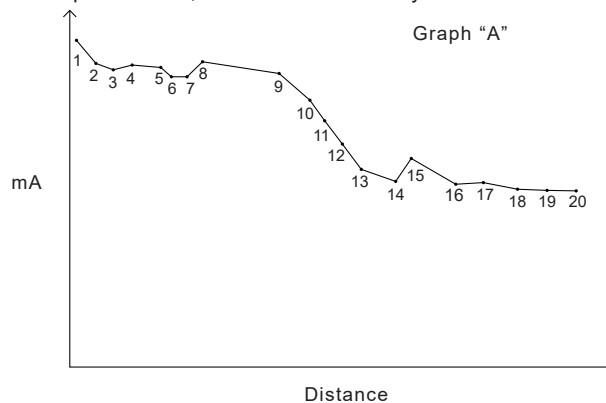

Also note the step response at points 1 to 2. This is typical of readings near the application point and may not represent a fault. The step is often caused by the concentration of ground currents at the application point or the cable leading to the ground bed. If in doubt check the section using the A-frame.

Using Logarithmic or Linear scales is a matter of personal preference. However, when looking for defects along a pipe similar defects further along the pipe can appear smaller than those near the application point. This is because there is less pick-up at a distance as the transmitter's signal is reduced. Using a logarithmic scale has the effect of compensating for this effect and is more likely to represent the defect's true magnitude, which is a long way down the pipeline.

10. Care and Maintenance

10.1 Cleaning

Cleaning can be done with a cloth dampened with warm soapy water. Do not use scouring pads on the casing or display surfaces as this will scratch the device. Do not submerge or pour water over the receiver or transmitter.

Always dry the equipment before storing it.

10.2 Checking Functionality

The vLoc3-DM system can be checked using a simple test procedure. It requires an area clear of pipes and cables and free from metallic structures such as metal tanks, metal railings, and reinforced concrete.

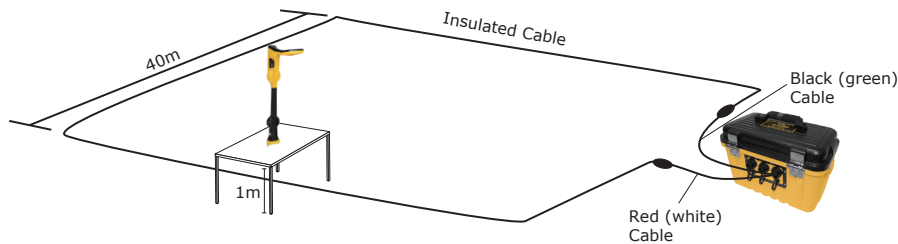

A 40m square loop of wire needs to be set out on the ground with a non-metallic structure placed at 1m above the cable and at the midpoint of one of the straight sections. See the diagram below.



Method:

- Set the transmitter to 128Hz (98Hz if in a 60Hz environment)/3Hz/6Hz, set the current to 100mA.
- Set the locator to receive 128Hz (or 98Hz). Position the locator on the non-metallic structure and carefully align it above and in line with the cable. Set the gain of the locator to read approximately 50%. Check that the line indicator is pointing North/South. If it is not, there could be an interfering signal, or you may be too near to a bend of the loop.
- Hold the locator very still and press the “I” pushbutton. After a few seconds a result will be displayed on the instrument.
- Check that the arrow is pointing back towards the white (or red) connection lead.
- Check the vLoc3-DM current reading is 100mA +/-10mA (10%).
- Check the depth is 1m +/-7cm.
- Repeat for each of the current settings of the transmitter.
- Successful completion of these tests confirms that both the receiver and transmitter are functional.

11. Glossary

Active Locate	A locate where a transmitter is used to apply a signal to a buried pipe or cable, the position of which is then located by a receiver tuned to the same frequency.
Active Signal	A signal applied by the locator transmitter to a buried line. Typical this is a very precise frequency.
Attenuation	The reduction of an electromagnetic signal from a pipe or cable.
Clamp (or Coupler)	An accessory used to apply the transmitter signal to an insulated line, removing the need to connect the transmitter signal directly to a conductor or cable sheath.
Compass	Line direction indicator (although visually like a compass, this is the only relation to a compass.)
Coupling	The act of signals transferring to lines to which they were not originally applied. The coupling can be "direct" where the target line has an electrical connection to another line or "induced" where the signal radiates from the target line to another line or lines.
Display	The information visually available on the dot matrix display.
Line	A generic term for any buried pipe or cable.
Null	A minimum response to a buried line. 
Passive Locate	A locate where the receiver searches for a wide range of signals that radiate from buried pipes or cables. These signals come from various sources in the environment and couple to the buried (& overhead) lines. Typical examples 50 / 60Hz and LF/VLF radio.
Passive signals	A wide range of signals that radiate from buried pipes or cables. These signals come from various sources in the environment and couple to the buried (& overhead) lines. Typical examples 50/60Hz and LF/VLF radio.
Peak	A maximum response to a buried line. 
Pinpoint	Using a receiver to identify the exact position of a buried line.
Response	The indication that the receiver gives is caused by the signals it is receiving. This can be visual, audio or both. Typically, it is displayed on the locator's dot matrix display and audibly from a loudspeaker in the receiver housing.
Search (sweep)	This describes the act of looking for a buried line within a given area.
Sonde	A small transmitting coil may be built into a product such as a sewer camera or packaged as a small self-contained battery-powered transmitter. A receiver tuned to the same frequency can locate the Sonde's position and hence whatever it is attached to or in. Sondes are frequently used for locating sewer cameras and tracing non-metallic pipes and ducts.
Target Line	The buried pipe or cable to be located.
Trace	Using a locator to follow the path of a buried line.

Illustrations used in this manual's preparation will inevitably show some resemblance to similar illustrations from other manufacturers. Credit is given to the manufacturers who have permitted the use of their graphics. This statement is intended to attribute such credit to these manufacturers.

Disclaimer: Product and accessory specification and availability information are subject to change without prior notice.

Notes:



Vivax-Metrotech Corporation
3251 Olcott Street, Santa Clara, CA 95054, USA
Toll-Free: 1-800-446-3392
Phone: +1 (408) 734-1400
Website: www.vivax-metrotech.com



